

# SYNOPSIS™ Starting Guide

SYNOPSIS™ (*SYNthesis of OPTical SYStems*)

Lens Design Software

[www.osdoptics.com](http://www.osdoptics.com)

[info@osdoptics.com](mailto:info@osdoptics.com)

SYNOPSIS™ is a trade name used by Optical Systems Design commercially since 1981.

# Table of Content

## 1. Basic Concept

- Starting SYNOPSIS™
- Important File Types: Lens Data Files and Macros
- Launching and Saving Files in SYNOPSIS™
- Reading the Lens Data
- Lens System Visualization Tools

## 2. Hands-on Exercises

- Ex1 Working with a Singlet
  - Ex1.1 Optimizing a Singlet
  - Ex1.2 Improve the Singlet by Adding an Element
- Ex2 Five Element System Design with DSEARCH
  - Ex2.1 Design by Experience (or Wild Guess)
  - Ex2.2 Design by DSEARCH

## APPENDICES

Macro files

Using Spreadsheet in SYNOPSIS™ to enter lens data

Singlet Lens Data File Commands Explained

Optimization Introduction

# Basic Concepts

If you have not yet done so, download and install the program from [www.osdoptics.com](http://www.osdoptics.com).

After installing SYNOPSIS™, you can start it by double clicking the SYNOPSIS™ shortcut icon on your desktop:



If you are running the trial version and do not yet have a license, you get the following messages. Just click through them as shown below:

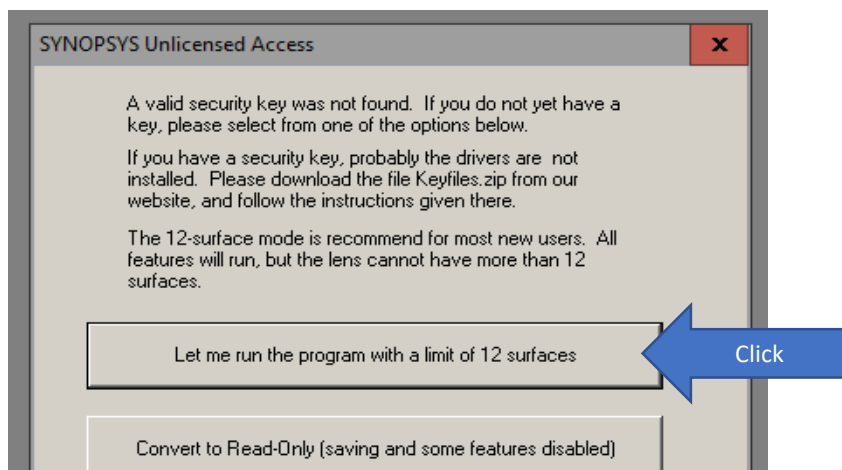
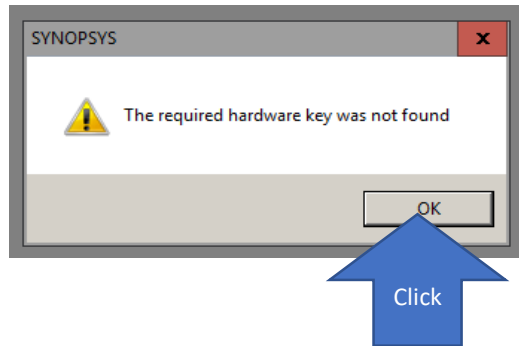

In SYNOPSIS™, there are two important file types: lens data file (.RLE) and macro file (.MAC).

1. Lens Data file (.RLE): The specifications for a lens are entered into SYNOPSIS™ by means of a data file of the structure shown below and is saved as a .RLE file.

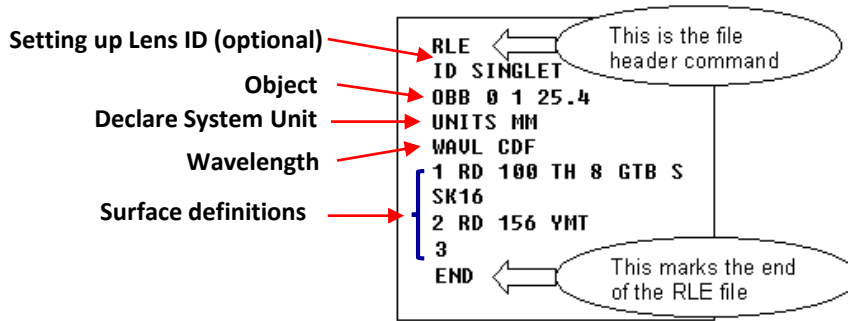

Available system wavelength commands:

```
WAVL L1 L2 L3
WAVL L1 L2 L3 L4 L5
WA1 L1 [ L2 L3 L4 L5 ]
WA2 [ L6 L7 L8 L9 L10 ]
WT1 W1 [ W2 W3 W4 W5 ]
WT2 W6 [ W7 W8 W9 W10 ]
```

Available object commands:

```
OBA TH0 YP0 YMP1 [ YP1 XP0 XP1 XMP1 ]
OBF TH0 YP0 YMP1 [ YP1 XP0 XP1 XMP1 ]
OBB UMP0 UPP0 YMP1 [ YP1 UXP0 XP1 XMP1 ]
OBC TH0 UPP0 YMP1 [ YP1 UXP0 XP1 XMP1 ]
OBD TH0 UPP0 YMP1 [ 0 UXP0 0 XMP1 ]
OBG WAIST [ RBS [ WAISTx [ RBSx ] [ M2 ] ] ]
OBJECT FINITE TH0 YP0 [ XP0 ]
OBJECT INFINITE UPP0 [ VPP0 ]
REFERENCE HEIGHT YMP1 [ YP1 XMP1 XP1 ]
REFERENCE ANGLE UMP0 [ YP1 VMP0 XP1 ]
```

For more information on the lens data input format, refer to **User Manual 3.0 Lens Data Input**.

You can save the .RLE file in the working directory folder or the Lens Library:

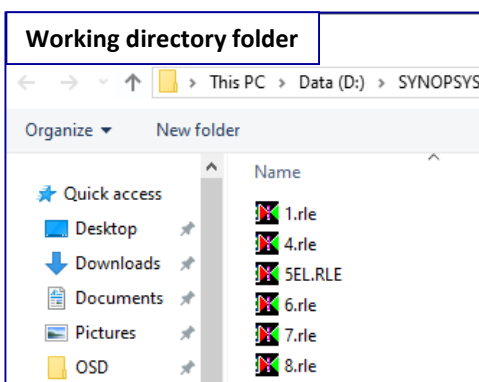

CONTENTS OF THE LENS LIBRARY	
LOCATION	LENS ID
1	ID MIT 1 TO 2 UM LENS
2	ID RAYZOOM A
3	*** EMPTY LOCATION ***
4	ID RELAY FLAT
5	*** EMPTY LOCATION ***
6	ID TRIPLET START
7	ID KOSO LENS 1:1
8	ID IATTEL EYEPIECE
9	ID START FROM FLAT
10	ID NEW LENS

We mostly save and launch files from the working directory.

Lens Library is a designated storage space for up to 10 lenses. This is a practical place to store lenses under active development since some of the features of SYNOPSIS™ can read these data and their flexibility is thereby enhanced (See **User Manual 3.7.1 The Lens Library**). The 10 locations associated with the lens library are displayed when you first launch SYNOPSIS™. Also, the lens that you are working on is automatically saved into location 10 of the Lens Library.

2. Macro (.mac): MACros are sequences of SYNOPSIS™ command or AI sentences, entered in the Macro Editor window and usually saved to disk. Macros reside in your working directory only.

You can have any number of MACro editor windows open at the same time. Much of the work you do in SYNOPSIS™ will require several lines of input, and it is much easier to accomplish what you want if you prepare a MACro first. Then you can easily rerun or edit the MACro if necessary, and save it to disk for use at another time.

Macro files are mostly used for specific analysis such optimization and automatic search. You can also incorporate the lens data construct in the macro but we recommend not to do so because we may need to run the optimization multiple times. If you put your initial lens definition in the same macro, you may run the risk that the initial lens system will be launched and replaced the newer version of the lens system that have been optimized.

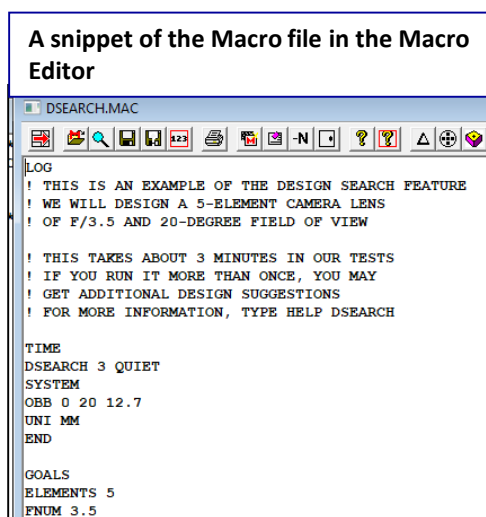
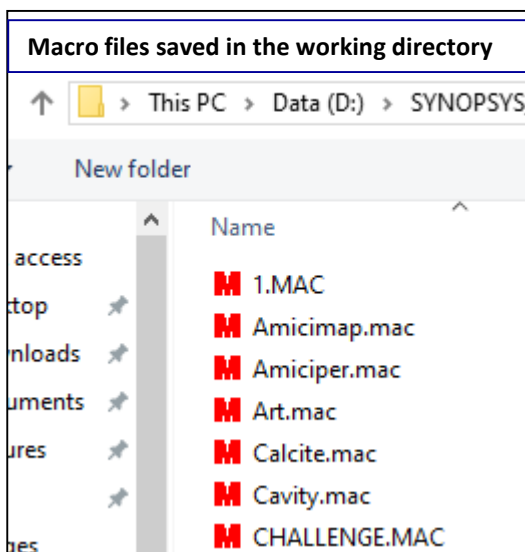

The macro editor toolbar not only provide access to standard functionalities such as saving, opening, and printing the macro files. It also has a set of buttons that are built in for the access of optimization menu (MOM) with which you can set up your optimization macro easily. For more details of the macro toolbar and the SYNOPSIS™ commands to launch, open, and run the macro files, please refer to **APPENDIX: Macro files**.

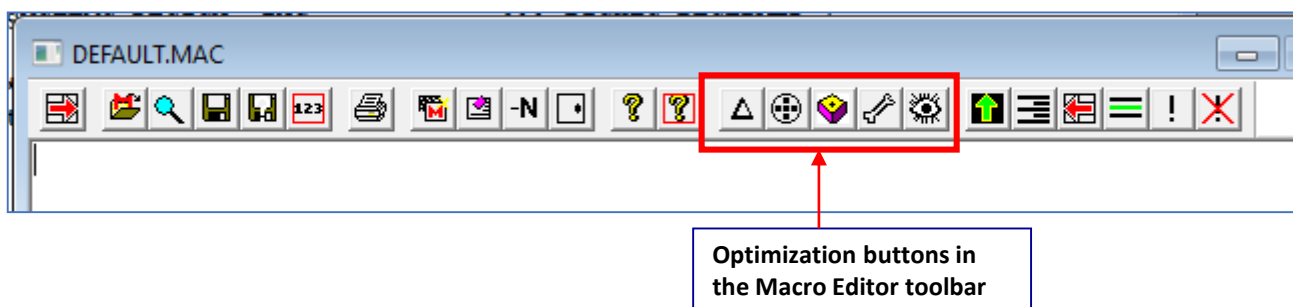

**Launching an existing Lens Data File (.RLE) from the working directory**

There are different ways to launch a lens data file (.rle). Here we will introduce the most basic operation: use the 'open a Lens File' option from the top menu:

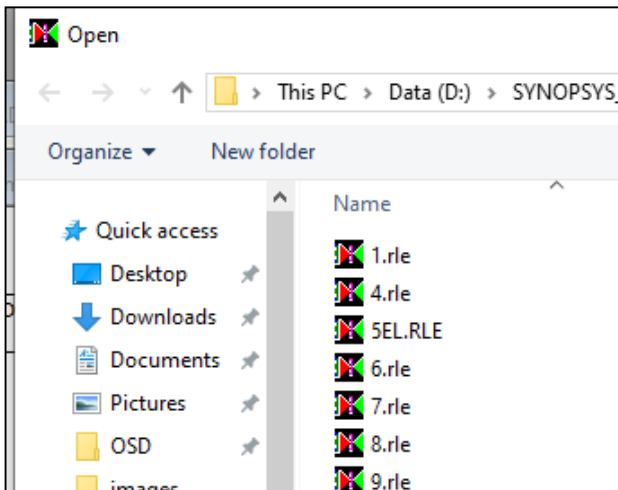
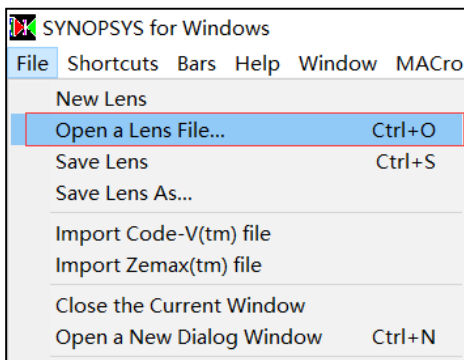

You can also use the command FETCH filename to open an existing lens data file. For example:

**SYNOPSIS AI>FETCH SINGLET**

Once the file is launched, SYNOPSIS™ will automatically execute the PXT (paraxial raytrace) and SPEC (Lens Specifications, **User Manual 4.1**) command for the RLE file and present the paraxial characteristic of the lens system, as well as its specifications (SPEC), in the Command Output Window.

Paraxial raytrace (PXT) result

```
SYNOPSIS>          GIHT          FOCL          FNUM          BACK          TOTL
      8.53727      97.58144      3.84179      95.91907      5.00000      0.00000
ID EXAMPLE SINGLET          168          08-SEP-19      13:02:03
LENS SPECIFICATIONS:
```

SYSTEM SPECIFICATIONS

OBJECT DISTANCE (TH0)	INFINITE	FOCAL LENGTH (FOCL)	97.5814
OBJECT HEIGHT (YPP0)	INFINITE	PARAXIAL FOCAL POINT	95.9191
MARG RAY HEIGHT (YMP1)	12.7000	IMAGE DISTANCE (BACK)	95.9191
MARG RAY ANGLE (UMP0)	0.0000	CELL LENGTH (TOTL)	5.0000
CHIEF RAY HEIGHT (YPP1)	0.0000	F/NUMBER (FNUM)	3.8418
CHIEF RAY ANGLE (UPP0)	5.0000	GAUSSIAN IMAGE HT (GIHT)	8.5373
ENTR PUPIL SEMI-APERTURE	12.7000	EXIT PUPIL SEMI-APERTURE	12.9201
ENTR PUPIL LOCATION	0.0000	EXIT PUPIL LOCATION	-3.3536

```
WAVL (uM) .6562700 .5875600 .4861300
WEIGHTS 1.000000 1.000000 1.000000
COLOR ORDER 2 1 3
```

```
UNITS MM
APERTURE STOP SURFACE (APS) 1 SEMI-APERTURE 12.77165
FOCAL MODE ON
MAGNIFICATION -9.75814E-11
GLASS INDEX FROM SCHOTT OR OHARA ADJUSTED FOR SYSTEM TEMPERATURE
SYSTEM TEMPERATURE = 20.00 DEGREES C
POLARIZATION AND COATINGS ARE IGNORED.
SURFACE DATA
```

SURF	RADIUS	THICKNESS	MEDIUM	INDEX	V-NUMBER
0	INFINITE	INFINITE	AIR		
1	100.00000	5.00000	N-BK7	1.51679	64.17 SCHOTT
2	-100.00000	95.91907S	AIR		
IMG	INFINITE				

KEY TO SYMBOLS

A SURFACE HAS TILTS AND DECENTERS	B TAG ON SURFACE
G SURFACE IS IN GLOBAL COORDINATES	L SURFACE IS IN LOCAL COORDINATES
O SPECIAL SURFACE TYPE	P ITEM IS SUBJECT TO PICKUP
S ITEM IS SUBJECT TO SOLVE	M SURFACE HAS MELT INDEX DATA
T ITEM IS TARGET OF A PICKUP	

THIS LENS HAS NO SPECIAL SURFACE TYPES  
THIS LENS HAS NO TILTS OR DECENTERS

Launching an existing Lens Data File (.RLE) from the Lens Library

To get a .rle file from the Lens Library, one can use the command GET:

```
SYNOPSIS>GET 1
```

Paraxial raytrace (PXT) result

```

THIS LENS HAS NO TILTS OR DECENTERS
SYNOPSIS AI>GET 1

Get lens no. 1          ID MIT 1 TO 2 UM LENS          3119
      GIHT             FOCL             FNUM             BACK             TOTL             DELF
      6.13932         50.00075         1.42859         16.29978         49.77532         0.00000
SYNOPSIS AI>
    
```

Or use the Lens Library menu button to select the Lens Data File in the MLB dialogue:

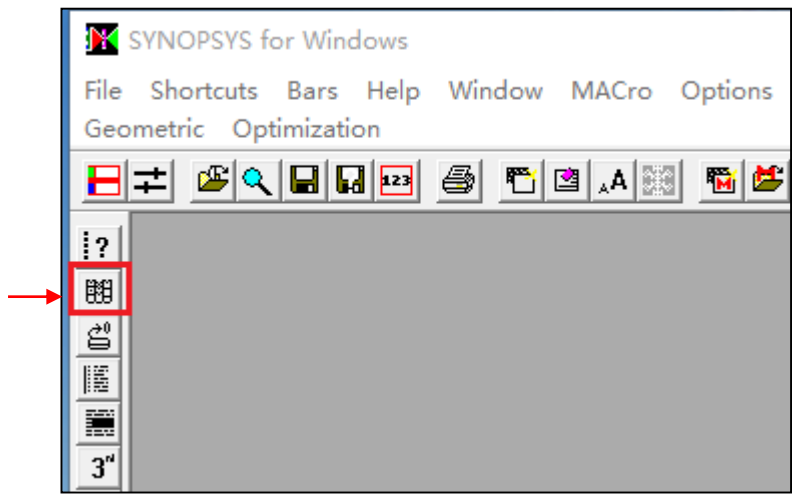

MLB -- Lens Library Functions

Lens No.	Identification	Log Number	Merit
1	ID MIT 1 TO 2 UM LENS	3119	0.000000
2	ID RAYZOOM A	1	0.000000
3	*** EMPTY LOCATION ***		
4	ID RELAY FLAT	141	0.000000
5	ID TRIPLET START	20	0.118769
6	ID TRIPLET START	5721	0.000000
7	ID KOSO LENS 1:1	119	0.000000
8	ID IATTEL EYEPIECE	28273	0.000000
9	ID START FROM FLAT	28346	0.000000
10	ID MIT 1 TO 2 UM LENS	74	0.000501

STORE into selected location  
 GET from selected location



### Saving your Lens File

To save a file into the working directory, you can use the command **SAVE**. For example,

```
SYNOPSIS AI>SAVE SINGLET ('singlet' is the filename)
```

Or, you can Store the file into the Lens Library by using the command **STORE**:

```
SYNOPSIS AI>STORE 3
```

This stores the lens file in location 3 of the lens library.

Lens No.	Identification	Log Number	Merit
1	*** EMPTY LOCATION ***		
2	*** EMPTY LOCATION ***		
3	ID EXAMPLE SINGLET	168	0.000000
4	*** EMPTY LOCATION ***		
5	ID 5 ELEMENT DSEARCH	175	0.031360
6	ID 5 ELEMENT DSEARCH	175	0.170617
7	*** EMPTY LOCATION ***		
8	*** EMPTY LOCATION ***		
9	ID EXAMPLE SINGLET	168	0.000000
10	ID EXAMPLE SINGLET	175	17.005500

### Saving your Macros

To save your Macro, you can use the 'save' or 'save as' buttons in the Macro Editor:

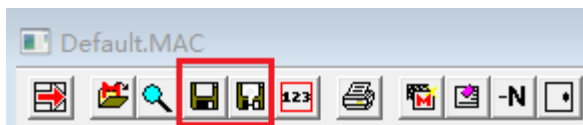

When you click the run button in the Macro Editor, SYNOPSIS™ will automatically save your macro under the same name shown at the upper left corner of the macro editor (which is default.mac for any unsaved or unnamed macro that you are working on). Do the followings before you click run, if you don't want to overwrite your current macro:

1. Save your current macro by clicking the 'save' or 'save as' button at the macro editor (or same buttons at the Command Window top toolbar) with the filename of your choice:
2. Then you can save the work-in-progress macro under a different filename before making changes so that the new changes will be saved into the new filename when you click 'run'.
3. Another way to do this is to change the name at the current macro editor window back to the Default.MAC by clicking the 'Rename Default.mac' button before running it.

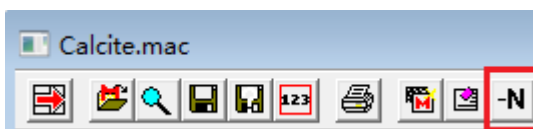

When you click the 'run' button, the current macro (with all the changes) will be saved as Default.mac automatically without overwriting the macro file you just saved.

For more information on the Macro Editor toolbar and other commands, see **APPENDIX: Macro Files**.

### Viewing the Lens Data with Lens Editor

There are several ways to view the lens data after you launch the .rle file.

1. Lens Editor: In the command line input, key in the command LE (Lens Editor, **User Manual 13.3.3**) to open a dedicated Macro window in which SYNOPSIS™ puts a copy of the lens data in the RLE-format.

```
SYNOPSIS AI>LE
```

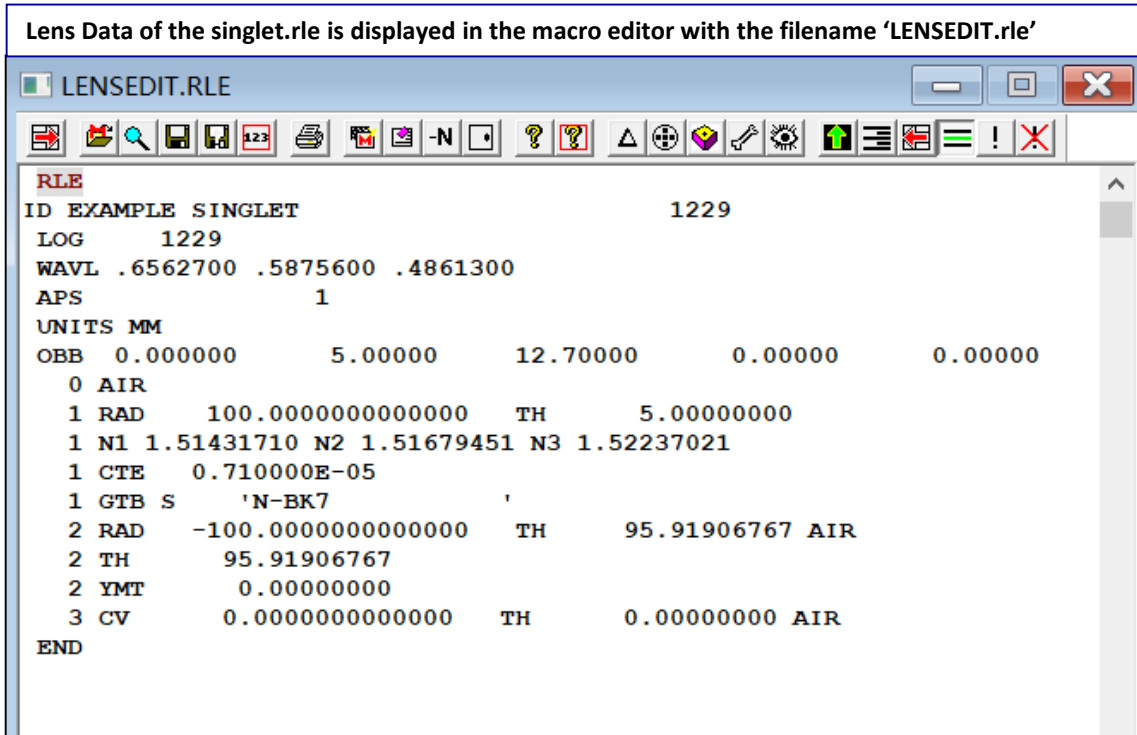

To make changes to the lens data, you can just change it in place in the Lens Editor by keying in the new data to replace the old one. Or, you can do the same by commenting out the current line and inserting a new line with new data. Then you can click the run button to update the lens.

For example, to change the RAD (radius of curvature) of the 2<sup>nd</sup> surface from -100 to -50, you will first add an exclamation mark in front of the RAD command line for the 2<sup>nd</sup> surface to comment it out. Then you will insert the new RAD line below it:

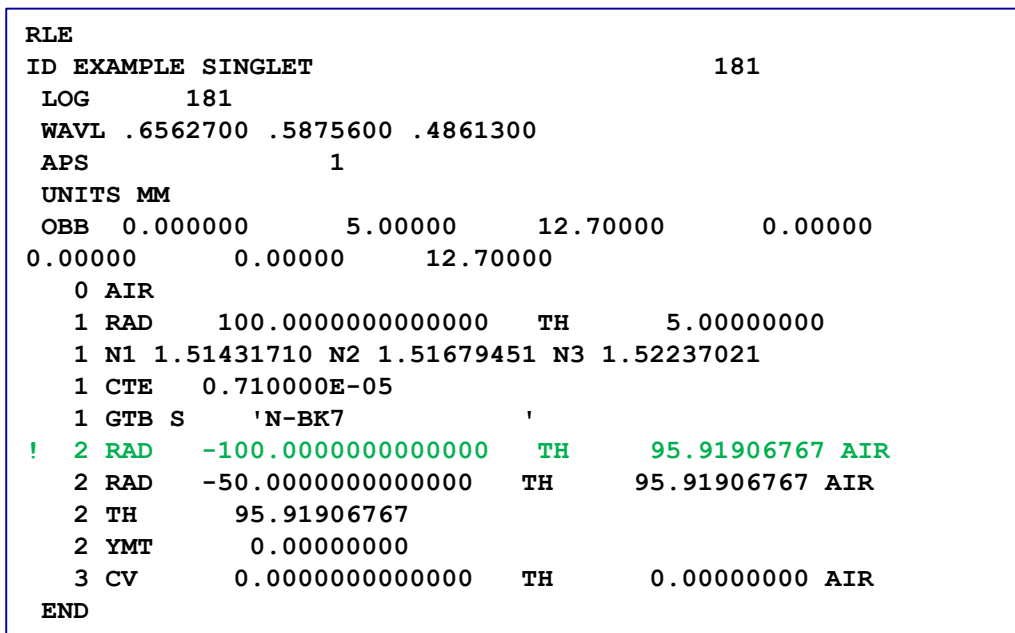

Another way to modify the lens data is by using the CHG (Change) file construct in SYNOPSIS™  
(User Manual: 3.6.1 The CHG file ):

To use **CHG**, enter an input file of the following form:

```
CHG  
    (data entry lines)  
END
```

**CHG** lines must be in the same format as members of an RLE file. The new values given for a surface parameter replace the old values. If a surface number entered in a **CHG** file exceeds the highest number previously in the lens, the corresponding surface is added to the lens. Surfaces not mentioned in the **CHG** file, and not subject to pickups or solves that are affected, do not change.

For example, the previous modification to the surface radius can be achieved by the following change file:

```
CHG  
    2 RAD    -50.0  
END
```

You can enter the commands one by one at the line input of the command window. Or you can put all the commands into one Macro Editor and then run the macro.

Viewing the Lens Data – Spreadsheet (SPS)

- 2. Spreadsheet: In the command line input, key in the command SPS to open a spreadsheet to view and edit the lens data.

SYNOPTSYS AI>SPS

Or you can use the Spreadsheet button in the SYNOPTSYS™ main toolbar to open it.

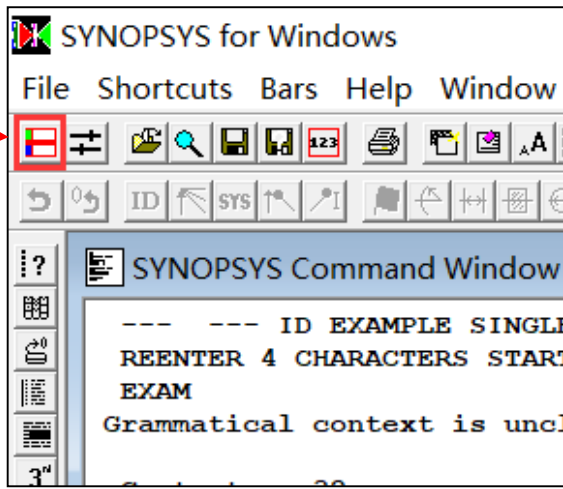

Spreadsheet in SYNOPTSYS™

S.N.	Radius	Conic Constant	Thickness	GlassType	N1	N2	N3	N4
1-25								
26-50								
0	F	infinite	0		1	1	1	
1	S	100	5	N-BK7	1.51432	1.51679	1.52237	
2	S	-100	95.9190677		1	1	1	
3	F	infinite	0		1	1	1	
4								
5								
6								
7								
8								

**Note:** to learn more about the spreadsheet in SYNOPTSYS™, use keyword SPS in the Index tap of the SYNOPTSYS™ Help. Or, refer to APPENDIX: Using Spreadsheet in SYNOPTSYS™ to enter lens data.

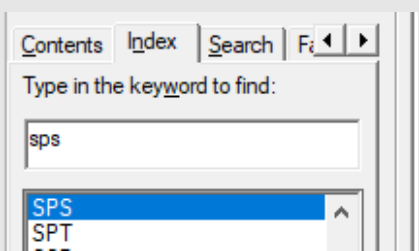

Viewing the Lens Data – WorkSheet (WS)

- Worksheet: In the command line input, key in the command WS (WorkSheet, **User Manual 13.3.2**) command to open the WorkSheet to view and edit the lens data.

SYNOPTSYS AI>WS

Or you can use the WorkSheet button in the SYNOPTSYS™ top toolbar to open it.

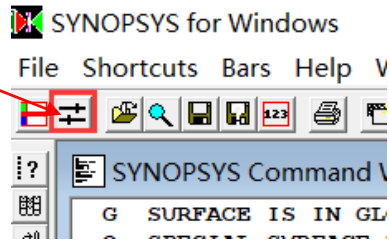

When you open the WorkSheet in SYNOPTSYS™, it will automatically open SketchPad (the lens system visualization tool in SYNOPTSYS™). Also, the WorkSheet toolbar will appear underneath the SYNOPTSYS™ main toolbar:

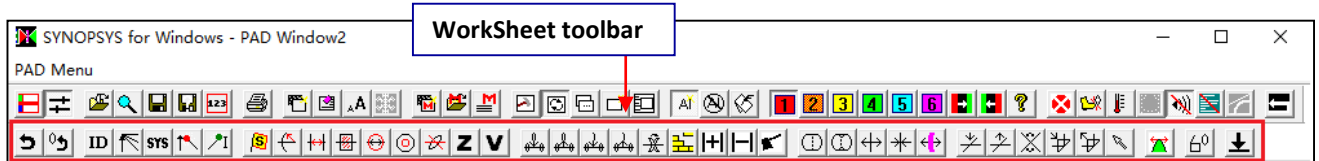
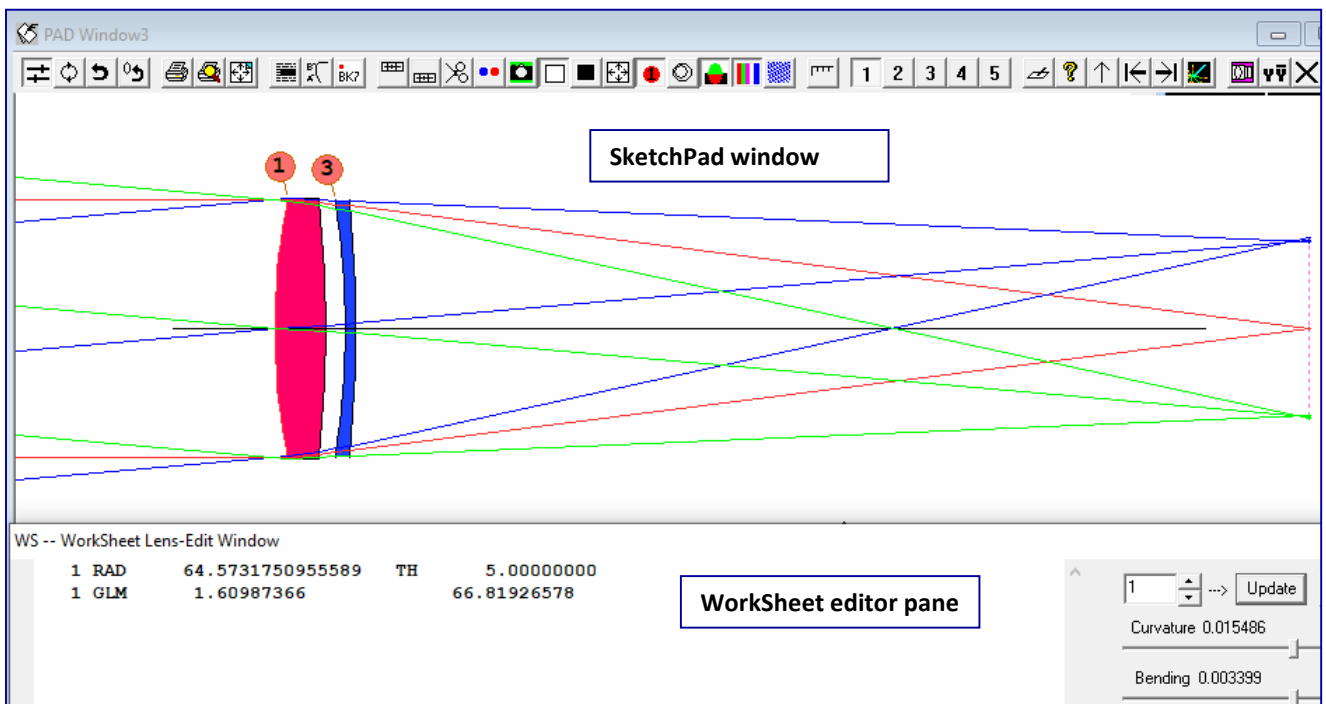

The Worksheet also shows an edit window that displays the parameters of a selected surface in RLE format, which you may edit. You may enter anything in this window to change the lens system (for example, change the radius of curvature of a surface). When you click on the Update button, the changes are applied to the lens and the PAD display is updated.

Worksheet is a very versatile construct in SYNOPTSYS™. There are a lot of design functions built into the WorkSheet and made available via the WorkSheet toolbar. We will talk more about it later.

### SketchPad™, Graphic View of Lens System and Characteristics

To view the lens layout and its characteristics, type **PAD** into the Command Window,

SYNOPTSYS AI>PAD

or click the SketchPad button in the Command Window top toolbar to open the SketchPad™.



The SketchPad™ is the primary graphical interface for SYNOPSIS™. You can use it to:

- View the lens and the image in many formats.
- Watch the lens change as you optimize
- Watch the image change as you alter the lens with the WorkSheet™ (WS).

The SketchPAD feature is a graphics window that can show either one or two displays simultaneously. It is typically used to view the lens drawing and a display of image quality at the same time. This is an interactive window that you can open, fill with your choice of display formats, and then update at any time with the update button to see the current lens and its image characteristic displayed in the chosen format. It is also updated whenever you GET or FETCH a lens, and during optimization if you have entered the **SNAPSHOT** command.

Update button

Use this two buttons to define the contents in the upper and lower displays in the PAD window

Lens Layout is displayed in the top half of the SketchPad window.

System performance characteristic is displayed in the lower half. In this example, it is showing the transverse ray fans. You can change it to other content, for example, OPD by using the format button for the lower PAD.

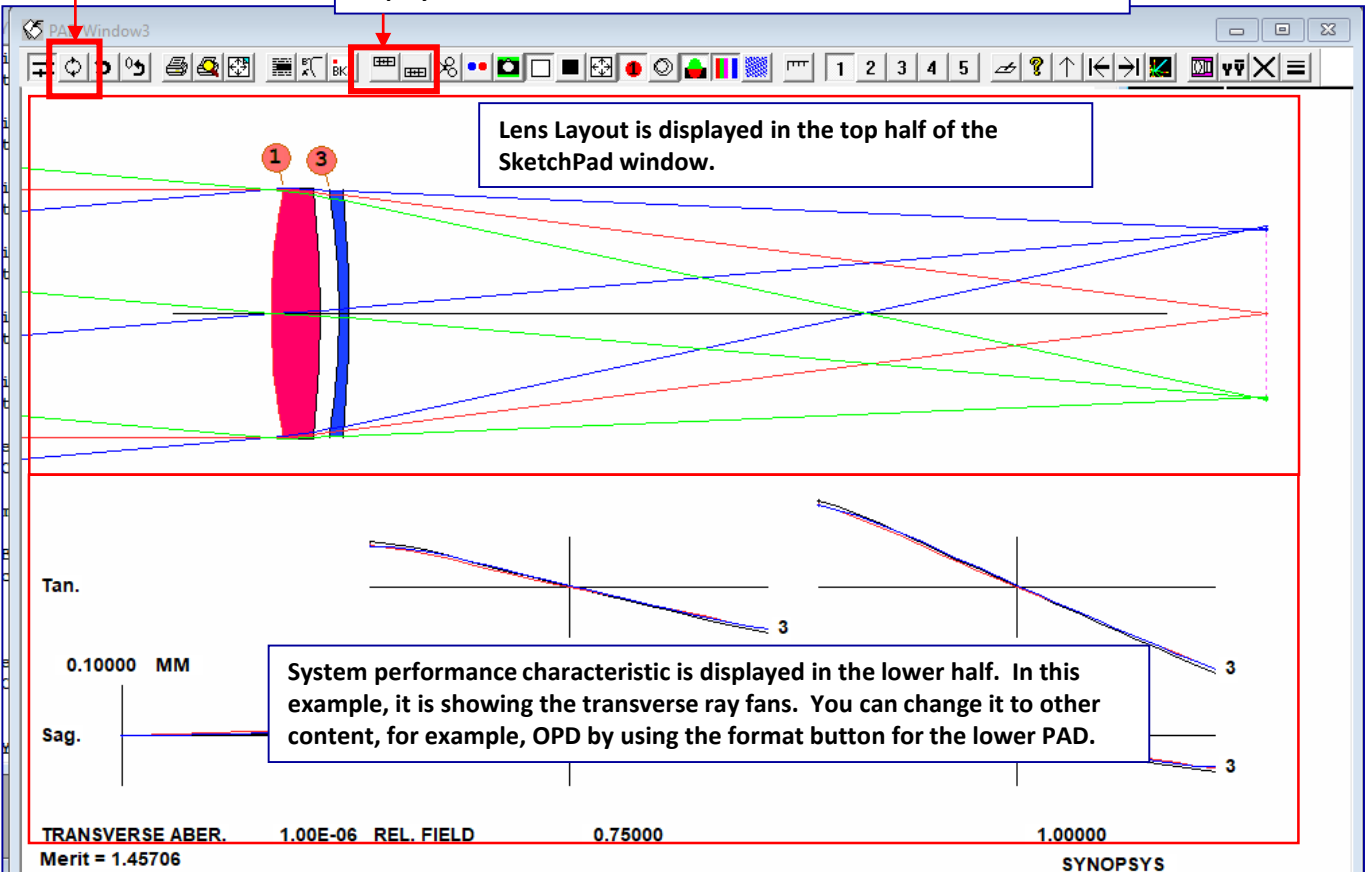

Note:

1. Type **HELP PAD** in the command line to read more about it (**User Manual 13.3**).
2. Sometimes if the PAD window doesn't open, you can type in the command **RESTORE** or **PAD ZERO** to restore the PAD window in your monitor.

## SketchPad™ (PAD) and WorkSheet™ (WS)

In the last section, we introduced WorkSheet (WS) as a lens data editing tool. However, WS is actually more than that.

- It is an integrative platform to work with SketchPad to give you instant feedback as you alter the lens in a variety of ways.
- Moreover, you can use the WS toolbar (appear underneath the SketchPad toolbar when WS is open) to manipulate the lens system such as inserting and removing surfaces, folding mirrors and elements, flipping an element or mirror around, or creating a checkpoint to which you can later revert with the Undo button.
- The Worksheet also shows an edit window that displays the parameters of a selected surface in RLE format, which you may edit. You can use the 'up' and 'down' arrows next to the surface number to go to other surfaces. Surface 0 is reserved for the display of system data.
- In addition, four slider bars are provided with which you may alter any parameter in the RLE file, including the curvature, bending, and thickness of a surface, or slide an element along the axis – all the while monitoring the effects with the PAD display. You can even select a data item in the edit window – not otherwise assigned to a slider – and vary it with the top slider after clicking on the SEL button. You can see how the sliders work by watching the video in this link:

<http://osdoptics.com/video/18112201.mp4>

### System data displayed in page 0 of the WorkSheet

WS -- WorkSheet Lens-Edit Window

```

RLE
ID MIT 1 TO 2 UM LENS          3119
FNAME '1.RLE
LOG      3119
WAVL 1.970100 1.529600 1.060000
APS      4
NOVIG
UNITS MM
OBB 0.000000    7.00000    17.50000    -1.05311    0.00000    0.00000    17.500
0 AIR
  
```

The screenshot shows a window titled "WS -- WorkSheet Lens-Edit Window" containing RLE data for a lens system. The data includes parameters for ID, FNAME, LOG, WAVL, APS, NOVIG, UNITS, and OBB. To the right of the text area, there are several slider controls for parameters like Curvature, Bending, Spacing, and Slide element.

Hint: You can use the 'undo' option in the 'Shortcuts' menu to undo the changes you made to the lens. The Shortcut menu is visible in the command window top toolbar.

Sometimes, the command window top toolbar is replaced by other tool bars when other modality (for example, the SketchPad is active). To retrieve the command window top toolbar, activate the command window by clicking at it and the top toolbar will appear.

SYNOPSISYS for Windows

File Shortcuts Bars Help Window MACro

- Undo Ctrl+Z
- Cut Ctrl+X
- Copy Ctrl+C
- Paste Ctrl+V
- Undo Lens Changes Ctrl+U
- Redo Lens Changes Ctrl+Y

The screenshot shows the "Shortcuts" menu in the SYNOPSISYS for Windows application. The "Undo Lens Changes" option is highlighted with a red box.

# Hands-on Exercises



## Exercise 1: Working with a Singlet

Now let us use a simple singlet example to demonstrate

- How to create a lens data file in SYNOPSIS™
- How to do optimization in SYNOPSIS™
- How to use the built-in element insertion tool to improve the singlet system

### Creating a new lens file, data entry

There are three basic ways to enter lens data

- With the MACro editor (EE): Quick and easy with command inputs
- Using the WorkSheet (WS): WS is a very powerful construct in SYNOPSIS™. The users can use it to build a new lens system as well as for modifying an existing lens.
- With the SpreadSheet (SPS): Intuitive, easy to learn

### Lens Data Entry with Macro Editor

For starters, we will learn how to enter the data for a singlet lens in an Editor Window. (See **APPENDIX: Using Spreadsheet in SYNOPSIS™ to enter lens data** to see how to do the same with the SYNOPSIS™ spreadsheet).

First, type **EE** in the Command Window to open a new Macro Editor.

```
SYNOPSIS AI> EE
```

Then type the commands shown below into the Macro Editor to define a singlet. The words in green after the '!' mark are comments.

```
RLE
ID EXAMPLE SINGLET           !Set Lens system ID 'EXAMPLE SINGLET'
OBB 0 5 12.7                 !define object at infinity by using the OBB command, (see Note 1)
UNIT MM                      !declare system unit to be MM
1 RD 100 TH 5 GTB S         !define 1st surface by specifying RD, TH, and Glass type , (see Note 2)
N-BK7
2 RD -100 YMT                !define 2nd surface by specifying RD, TH is determined by YMT solve , (see Note 3 )
3                             !define 3rd surface, a flat surface for the image plane
END
```

Note 1:

Define Object:

```
OBB UMP0 UPPO YMP1
```

UMP0 : marginal ray angle, 0 for object at infinity

UPPO: paraxial chief ray angle (in degree, half FOV), 5 degree in this example

YMP1: paraxial marginal ray height at next surface (semi-aperture), 12.7mm in this example

Note 2:

The general format for surface definition is:

```
sn opt1 opt2 opt3...
```

sn: surface number

opt1, 2, 3... are the surface characteristics, for example, radius of curvature (RAD, or RD), thickness (TH), glass type (glass table (GTB) or glass model (GLM))...

Note 3:

When we select the **YMT** solve, SYNOPSIS™ finds the thickness (T) such that the height (Y) of the marginal paraxial ray (M) will be the requested value (zero) at the next surface. In other words, surface 3 will be at the paraxial focus. This is an example of paraxial solve.

For more details on the commands, see **APPENDIX: Singlet Lens Data File Commands Explained**

# Ex1.1 Optimizing a Singlet

Then click the run button.



The MACro runs, and the following output is printed in the command window:

```
EXECUTING MACRO DEFAULT.MAC
--- RLE
--- ID EXAMPLE SINGLET
--- OBB 0 5 12.7
--- UNI MM
--- 1 RD 100 TH 5 GTB S
--- N-BK7
--- 2 RD -100 YMT
--- 3
--- END
      GIHT      FOCL      FNUM      BACK      TOTL      DELF
      8.53727    97.58144    3.84179    95.91907    5.00000    0.00000
Lens number  10 ID EXAMPLE SINGLET
SYNOPSIS AI>
```

**Results from the paraxial raytrace (PXT).**

When you click the RUN button at the Macro Editor, SYNOPSIS™ will automatically execute the PXT (paraxial raytrace) command for the RLE file and present the paraxial characteristic of the lens system in the Command Output Window.

## Viewing the Singlet in SketchPad

To view the lens layout and its characteristics, type **PAD** into the Command Window,

```
SYNOPSIS AI>PAD
```

Or click the SketchPad button in the Command Window top toolbar to open the SketchPad™.

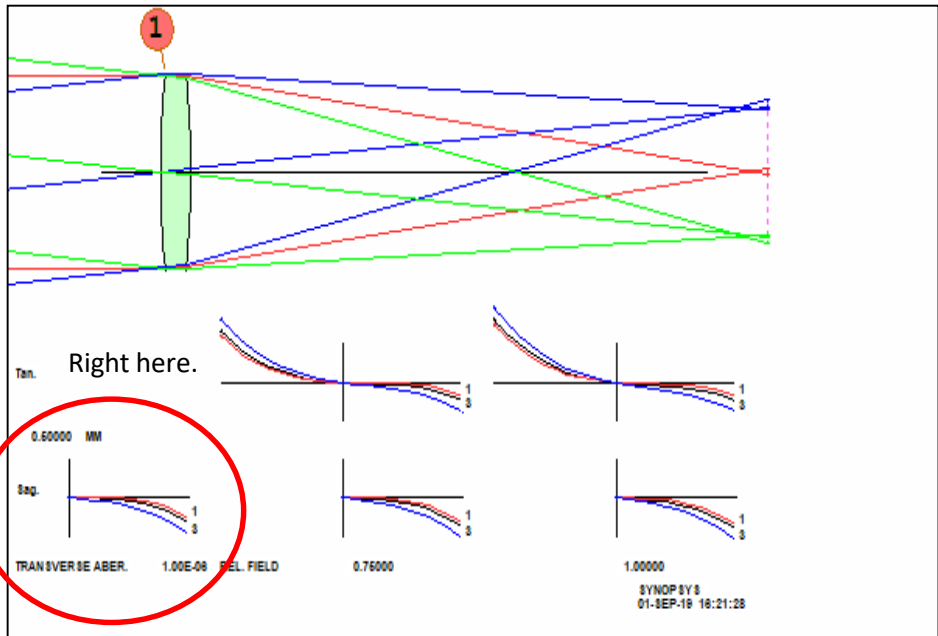
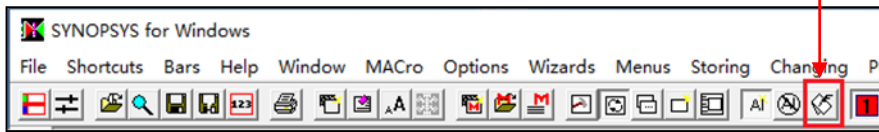

There are uncorrected spherical aberration (SA3) and primary axial color (PAC) as shown at the on-axis ray fans.

**Tip: type 'HELP PAD' in the command line to read more about it (User Manual 13.3).**

# Ex1.1 Optimizing a Singlet

Now we demonstrate how to use WorkSheet (WS) and SketchPad (PAD) together to change the radius of curvature for the first surface in the singlet.

Before making any changes to the system, let us keep a copy of the current system by clicking the Checkpointing button in the SketchPad :

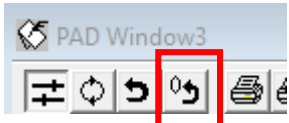

Then, open WorkSheet by clicking the WorkSheet button at the SYNOPSIS™ top toolbar:

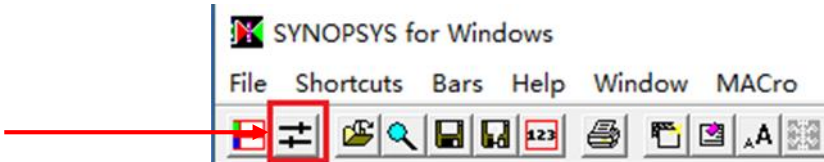

The WorkSheet™ opens, showing the System data (page 0).

WS -- Worksheet Lens-Edit Window

RLE									
ID	EXAMPLE SINGLET							76	
LOG	76								
WAVL	.6562700	.5875600	.4861300						
APS	1								
UNITS	MM								
OBB	0.000000	5.000000	12.700000	0.000000	0.000000	0.000000	0.000000	12.700000	
	0 AIR								

Curvature type not supported

Bending type not supported

Spacing type not supported

Slide element can't do

Click on surface 1 in the PAD Window:

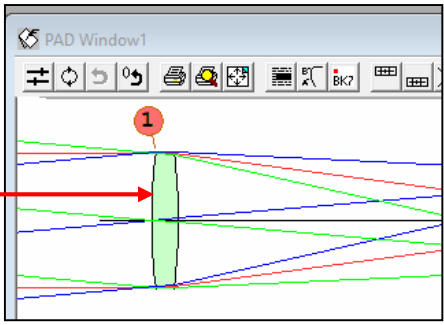

The edit pane in the WorkSheet now shows the data for surface 1. You can change any of these numbers, and when you click the Update button, you see how the lens changed.

WS -- Worksheet Lens-Edit Window

1	RAD	100.00000000000000	TH	5.00000000		
1	N1	1.51431710	N2	1.51679451	N3	1.52237021
1	CTE	0.710000E-05				
1	GTB	S	'N-BK7			

Curvature 0.010

Bending 0.0000

# Ex1.1 Optimizing a Singlet

In the WorkSheet pane for surface 1, Change the first radius to 50 and click Update.

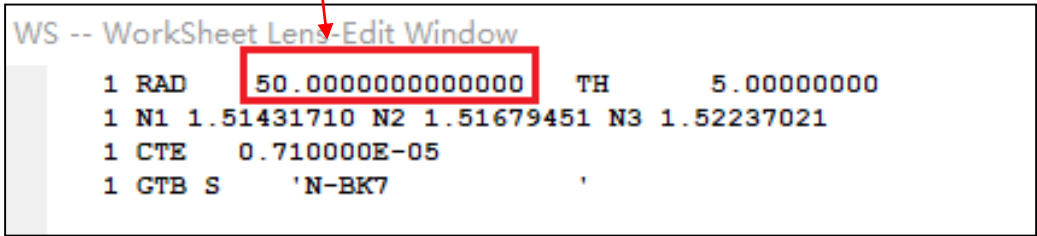
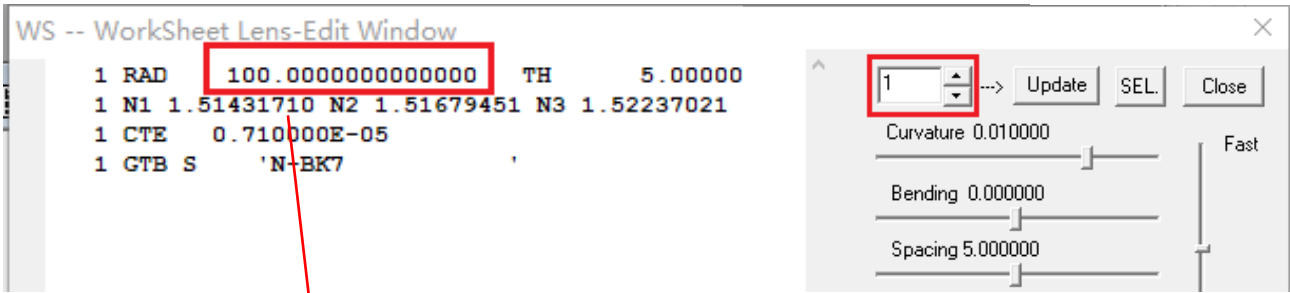

The lens is updated automatically in the SketchPad:

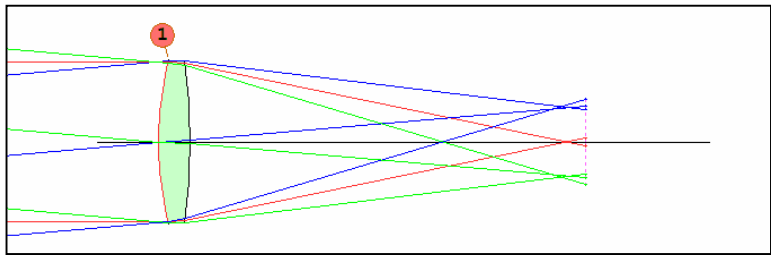

Now click the Restore button in the SketchPad, the lens come back as before with radius of curvature = 100 on surface 1.



Hint: You can use the 'undo' option in the 'Shortcuts' menu to undo the changes you made to the lens. The Shortcut menu is visible in the command window top toolbar. Sometimes, the command window top toolbar is replaced by other tool bars. To retrieve the command window top toolbar, activate the command window by clicking at it and the top toolbar will appear.

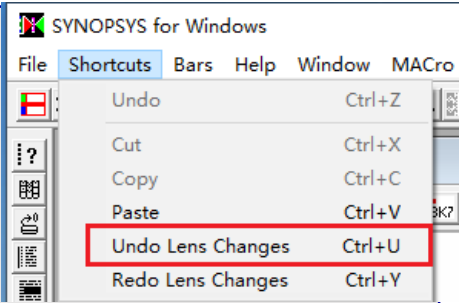

Now we will optimize the singlet (with the radius of curvature for the first surface = 100mm)

We will use the optimization program for this. It can be used for lots of things, not just improving the image. For example, you can constraint the mechanical characteristics of your systems such as total length by including a length target in your merit function.

Optimization is usually done by a set of special commands to be entered, edited, and saved as a Macro. You can modify and run the MACro as often as you want. Unlike other optical design software, you can save the optimization macro as a different file without the lens data. In SYNOPSIS™, lens description data is saved in the .RLE file and can be launched separately from the optimization macro.

The optimization macro includes the following sections/modules:

1. PANT section/module, to declare optimization variables
2. AANT section/module, to define the merit function, which can include the following quantities:
  - a. Optical ray aberrations.
  - b. Mechanical constraints; for example,
    - Aperture limits
    - Length limits
    - Paraxial properties not controlled by a solve
    - Etc.

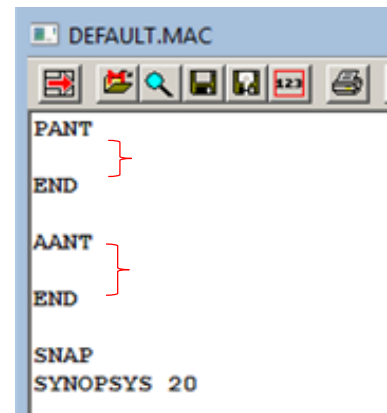

Here's the structure of an optimization macro:

**PANT** }  
**END**

The PANT section/module is where you define the design variables you want to use for optimization. (See **User Menu 10.2 Aberration Input.**)

**AANT** }  
**END**

The AANT section/module defines the merit function. It includes all the quantities that you want to incorporate into the merit function. (See **User Menu 10.3 Aberration Input.**)

**SNAP**

The SNAPSHOT command makes the PAD display update as the lens changes. (See **User Menu 13.3.4 SnapShot.**)

**SYNOPSIS 20**

The SYNOPSIS command starts the optimization. (See **User Menu 10.4 The SYNOPSIS Command.**)

# Ex1.1 Optimizing a Singlet

To enter the optimization macro, we will click at the new macro button at the Macro Editor to open a new window:

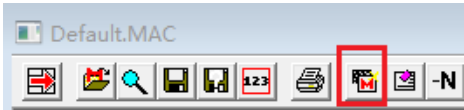

Or, we can open the MACro dialog at the top of the SYNOPSIS™ workspace. Then select 'open a new macro window':

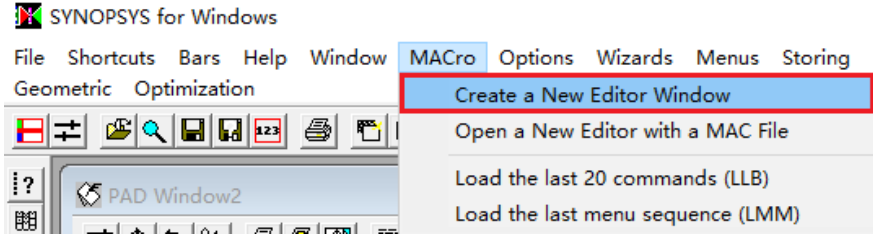

In the macro editor,

1. Input the **optimization variables** into the parameter input module (PANT...END);
2. Input the **aberration quantities** into the aberration input module (AANT...END).
3. Add the **SNAPSHOT** (SNAP for short) command to show the update system in the SketchPad.
4. Add the **SYNOPSIS** command to start the optimization iterations.

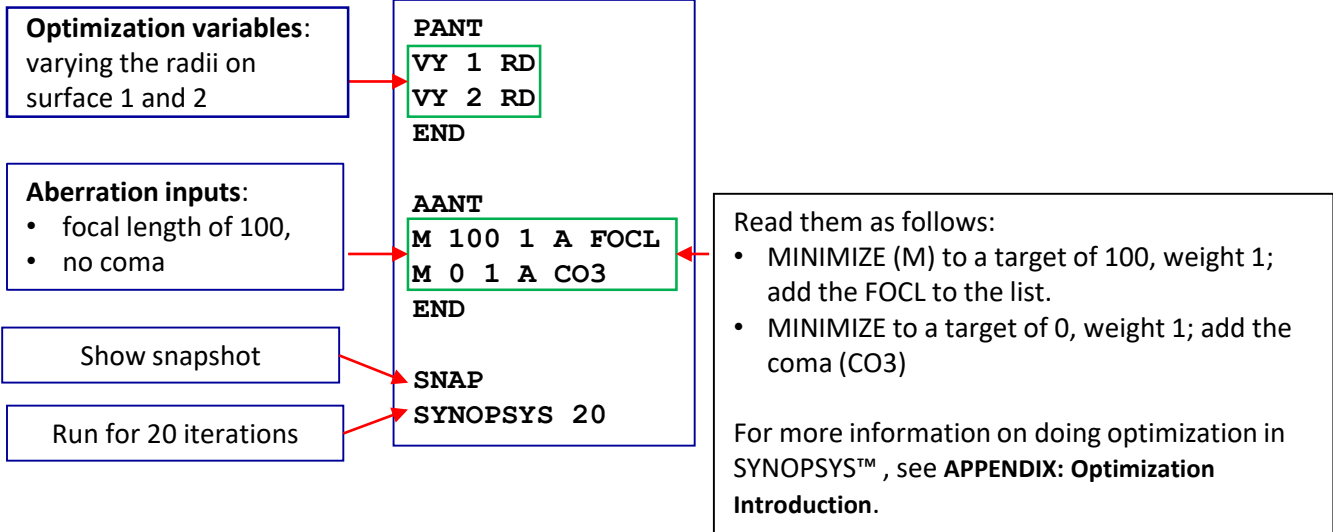

Now click the Run button to run the macro.



Now let's look at the print-out in the Command Window after running the optimization macro:

```

Iteration No.      1
Present merit function  5.918844E+00
Damping factor      5.000000E-01

Iteration No.      2
Present merit function  2.761606E-01

Iteration No.      3
Present merit function  3.697975E-05

Iteration No.      4
Present merit function  4.572332E-06

Iteration No.      5
Present merit function  1.268009E-09

Improvement in the merit function is below threshold value.
The KICK or ANNEAL function may further improve the lens.

Final merit function  7.499139E-22

Improvement in the merit function is below threshold value.
The KICK or ANNEAL function may further improve the lens.

Lens number      10 ID EXAMPLE SINGLET
SYNOPSIS AI>
    
```

After five passes, the merit function is close to zero.

Also note that the current lens file is saved in location 10 in the Lens Library with the lens ID 'Example Singlet' declared in the RLE file.

Type the command **FINAL** to read the resulting individual aberrations and its relative impact on merit function:

```

SYNOPSIS AI>FINAL

ABERRATION LIST
NAME      TARGET      WEIGHT      RAW VAL.  FINAL ERROR  R. EFFECT
1         100.000000    1.000000    100.0000  0.273701E-10 0.998945
  A FOCL
2         0.00000000    1.000000    -8.8948E-13 -0.889483E-12 0.001055
  A CO3
SYNOPSIS AI>
    
```

The COMA term is almost zero.

Both targets have been met exactly.

Note: for more information about the command **FINAL**, please refer to User Menu 10.9. This command is quite important because it tells you which factors in the system are the major hindrances in reaching the optimization goal as specified by the directives in the merit function.



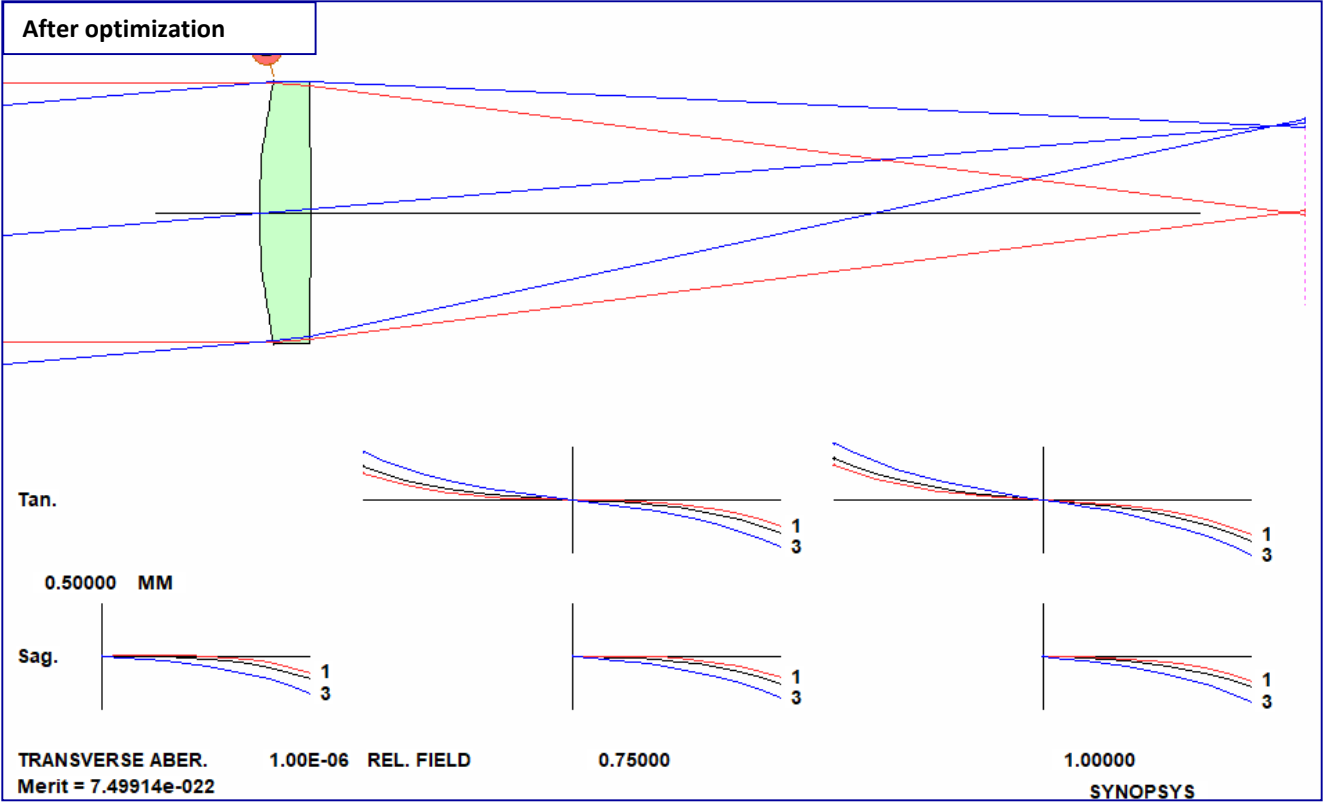
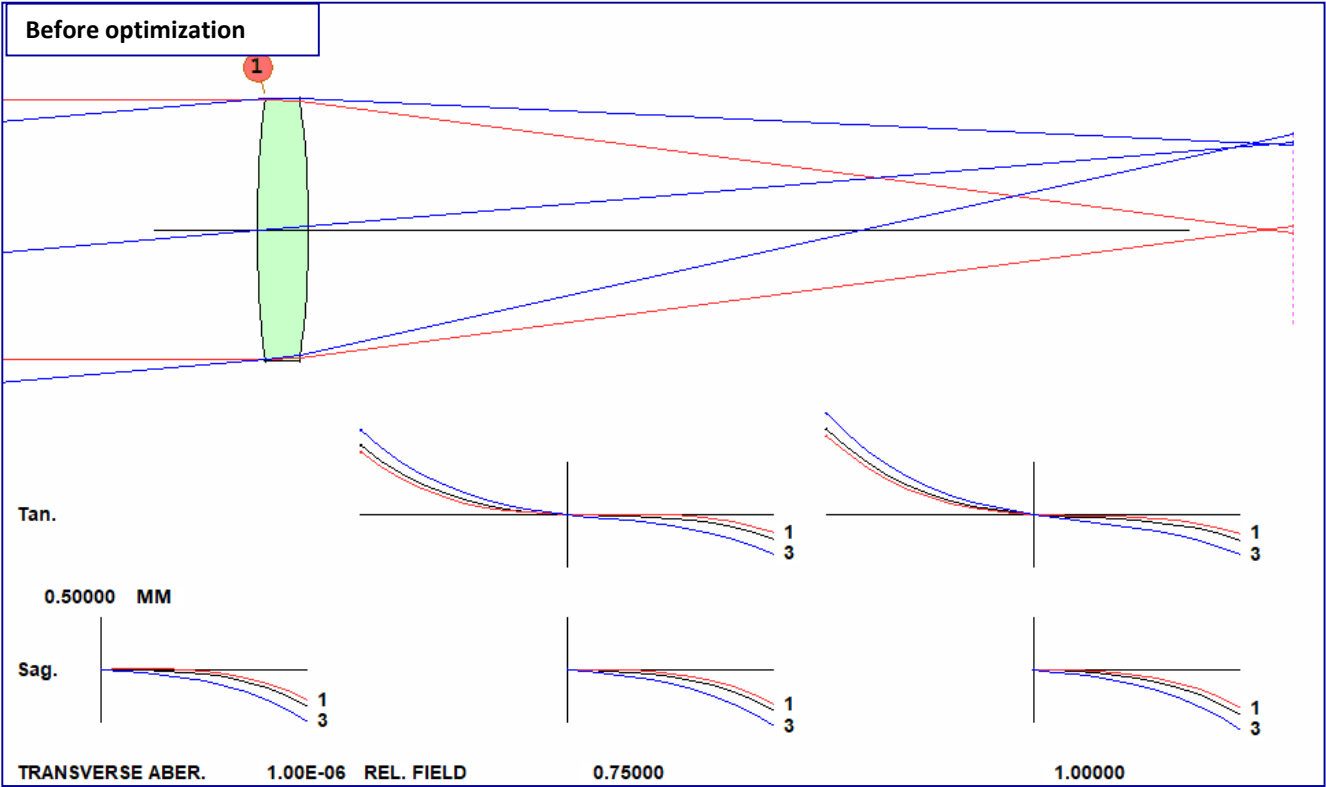

Now that you have seen a simple optimization, we'll show how to improve the singlet by adding an element.

For a singlet, there are totally 6 regular parameters (degrees of freedom) available for design or optimization: 2 radii, 1 thickness, 2 from material (index n and V number), and 1 APS position.

If we want to improve the optimized singlet further, we can increase the degree of freedoms to the system by, for example,

- Adding more components;
- Adding parameters to lens shape: aspheres, DOE, HOE;
- Adding parameters to lens material: gradient index lens;

Changing PARAMETERS (CONSTRAINTS) in optical system is the way of achieving technical, physical and other goals of technical specification.

In this section, we will show how to improve a singlet by:

- Adding a second element with WS (the WorkSheet).
- Freeing up the material on that element (it comes in with a pickup).
- Creating a merit function using the Ready-made Merit Functions in SYNOPSIS™
- Then optimizing again, now on the new system.

First, let's get back to the original singlet. We will open the lens file from your working directory by typing **FETCH SINGLET**.

**SYNOPSIS AI>FETCH SINGLET**

Once the lens file is retrieved, you will see the paraxial raytrace results printed in the Command Window. Then you can type PAD or click the PAD button in the Command Window top toolbar to launch SketchPad and examine the lens system .

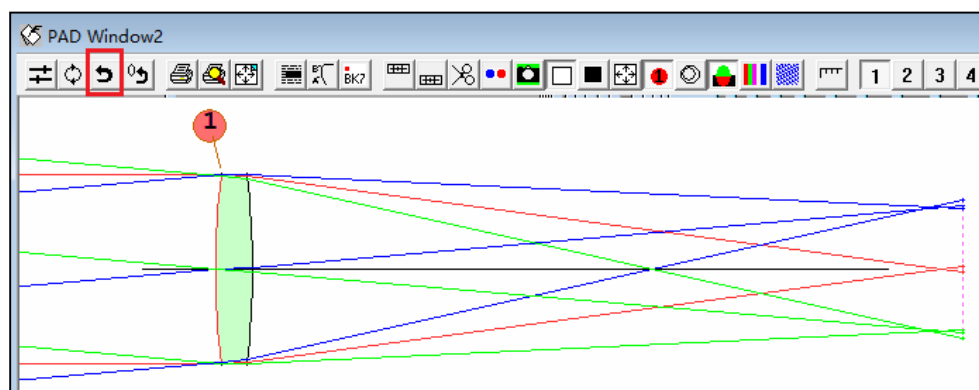
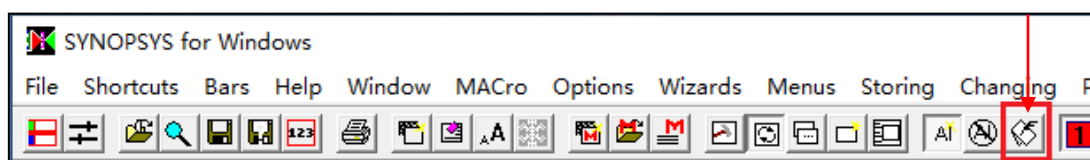

## Ex1.2 Improve the Singlet by Adding an Element

Now we will demonstrate how to insert an element into the current lens system by using the 'Insert Element' button in the Worksheet (WS) toolbar.

Open WS by clicking the 'open worksheet' button  at the Pad Window or the Command Window top toolbar. Once the Worksheet is open, You will find the Worksheet toolbar underneath the Command Window top toolbar. You can hover your cursor above each button to read its functionality.

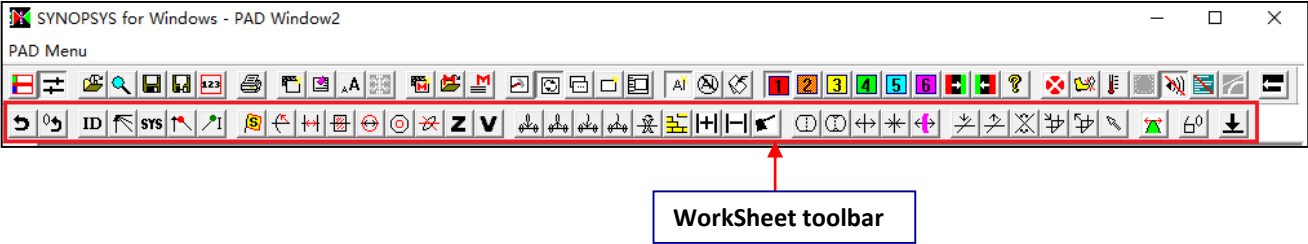

Click the 'insert an element' button in the WS toolbar.



Move your cursor into the SketchPad and you will notice that it turns into a small lens element symbol. Click behind the first element, on the axis, to add the new element.

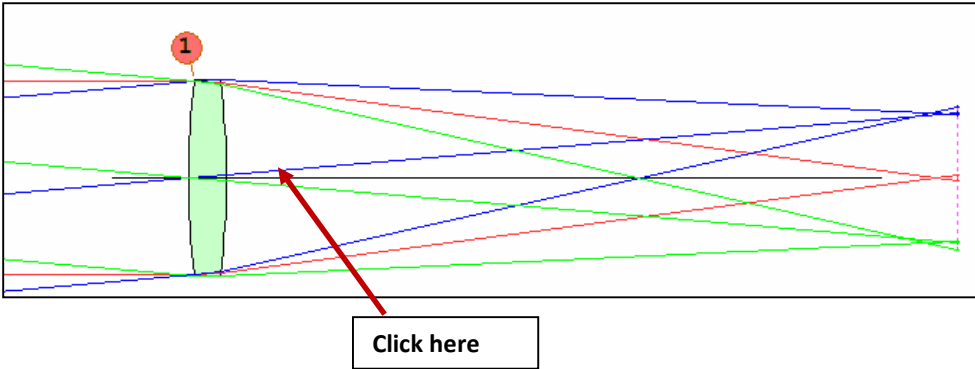

Then you will see an element added behind the singlet:

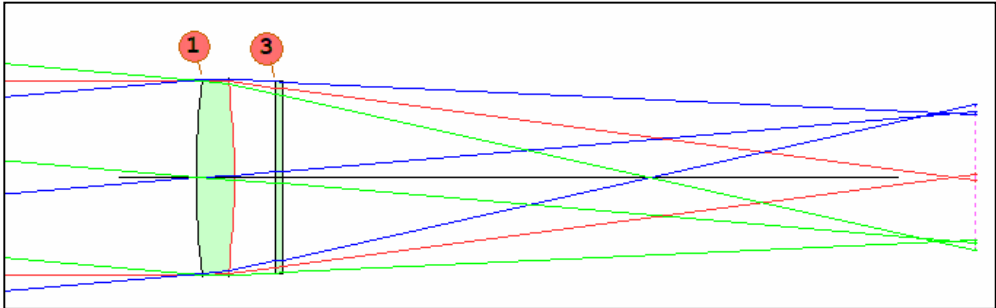

You've just added an element to the lens with WS.

## Ex1.2 Improve the Singlet by Adding an Element

Type LE in the command window to open the Lens Editor. This is your lens data file after adding the glass plate:

```
RLE
ID EXAMPLE SINGLET      !Set Lens system      181
LOG      181
WAVL .6562700 .5875600 .4861300
APS      1
UNITS MM
OBB 0.000000      5.00000      12.70000      0.00000
0.00000      0.00000      12.70000
 0 AIR
 1 RAD      100.00000000000000 TH      5.00000000
 1 N1 1.51431710 N2 1.51679451 N3 1.52237021
 1 CTE      0.710000E-05
 1 GTB S      'N-BK7      '
 2 RAD      -100.00000000000000 TH      2.13098425 AIR
 3 CV      1.00000000000000E-04 TH      1.00000000
 3 N1 1.51431710 N2 1.51679451 N3 1.52237021
 3 CTE      0.710000E-05
 3 GID 'N-BK7      '
 3 PIN      1
 4 CV      1.00000000000000E-04 TH      93.78808180 AIR
 5 CV      0.00000000000000 TH      0.00000000 AIR
END
PAD
```

Glass plate surfaces

You notice that the index for the glass plate is the same as the singlet (a BK-7):

```
1 N1 1.51431710 N2 1.51679451 N3 1.52237021
3 N1 1.51431710 N2 1.51679451 N3 1.52237021
```

When you add a new element to the system, the program has no information yet for the index of element 2, so it assigned a pickup of the index of element 1 indicated by the PIN (pickup index) command on surface 3:

```
3 PIN 1
```

Note:

You can also view the list of pickups and solves in effect in the system, type **POP** (Print Options) in the SYNOPSIS™ command window.

```
SYNOPSIS AI>POP

SUMMARY OF SURFACE CHARACTERISTICS AND ACTIVE OPTIONS
-----
SURF RSPC SURFACE SPECIFICATION          INSPC MEDIUM SPECIFICATION
-----
 1 1 RD                                -1 SCHOTT
 2 1 RD                                4 AIR
 3 2 CV                                3 PICKUP
 4 2 CV                                4 AIR
IMG 4 FLAT SURFACE                      4 AIR
-----
SOLVES, PICKUPS, AND OPTIONS
-----
 3 PIN 1
SYNOPSIS AI>
```

index pickup

## Ex1.2 Improve the Singlet by Adding an Element

We want to make the following changes to the system:

- Remove the index pickup so that the index for the new element is free to vary during optimization.
- Change the index for the two elements. Both elements are currently assigned with an index and V-number corresponding to the Schott BK-7, which sits very close to the boundary of the crown glass in a standard glass map. In this example, we are going to use the optimization method to drive the two elements (with same index and V-number) into a crown-flint doublet. If we start with both elements sit very close to the crown class boundary, there is not much room for the glass models to move in order to get to desired configuration (1<sup>st</sup> glass is a crown glass, and 2<sup>nd</sup> a flint). Therefore, we want to move starting point closer to the center of the glass map for the optimization process to move the two glasses into opposite directions.

There are Many ways to make the changes:

1. Enter a Change (CHG) file in the command window input line or in the Macro Editor (and run):

```
CHG
1 GLM 1.6 44
3 NIOP
3 GLM 1.6 44
END
```

2. Or you can do the changes In WS:

- i. Go to page 1 in WS, in the editor pane, type `1 GLM 1.6 44`. Then click update. The surface glass characteristic will be updated to be a Glass Model (GLM)

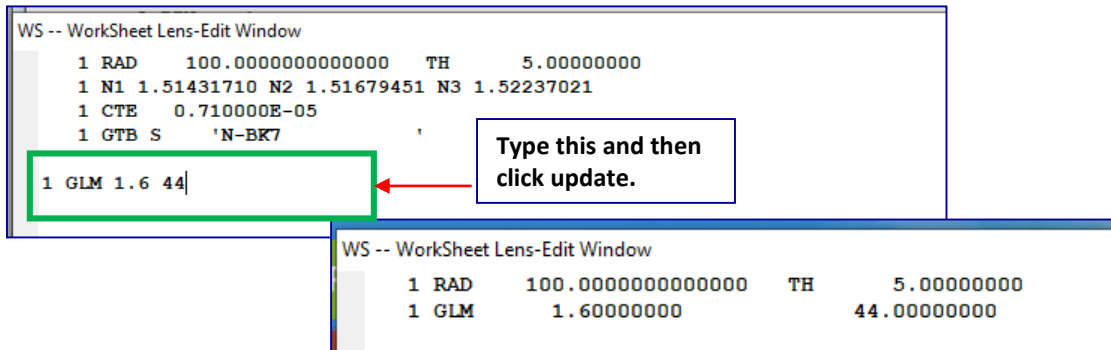

- ii. Go to page 3 in WS, in the editor pane, type the commands as shown below and then click update.

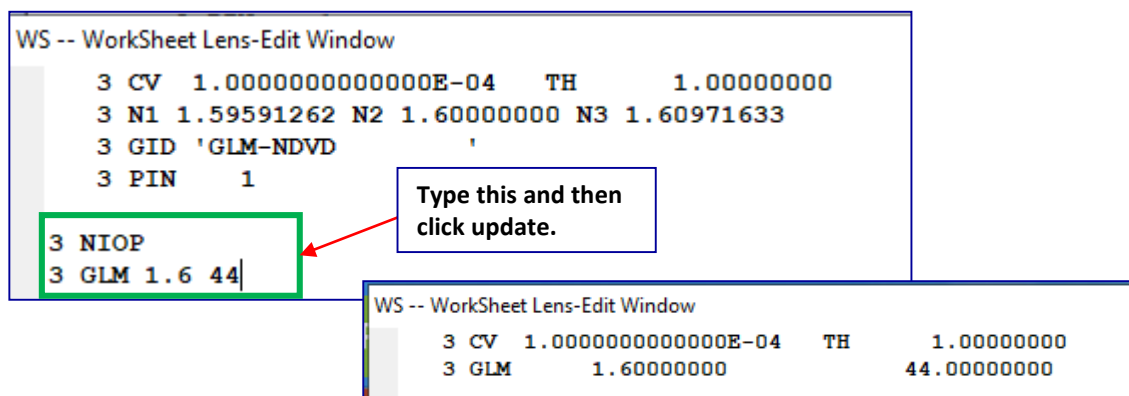

Note:

1. **SN NIOP** is a SYNOPSIS™ command: removes any index pickup or index calculation (from a GTB, GLM, GLASS, or GDF request). **SN** is the surface number.
2. You can also try to use the WS to continuously change the glass model using the slider. In WS, highlight the 1<sup>st</sup> number in the glass model (ie, the index). Click the SEL (select) button. The 1<sup>st</sup> slider now is assigned to the index. You can change the index of the glass using the slider and see how the system changes real time. Before you slide it, it is a good practice to first make a check point for the original system so that you can always go back. Things can go crazy easily with the slider.

### Ex1.2 Improve the Singlet by Adding an Element

The next step is to create an optimization macro for this system. Start a new macro editor window. Type in the commands shown below:

```
PANT
VLIST RAD ALL
END

AANT
M 100 1 A FOCL
END

SNAP
SYNOPSIS 40
```

This will vary all radii that are not flat and don't pick up another value.

Put the cursor right here.

And then click the 'Ready Made Raysets' button in the Macro Editor to open the Select Merit Function dialogue to see a list of handy merit functions.



Select Merit Function 6. Then click at the 'Back to MACro editor' at the top of the dialog box. The command block for Merit Function 6 will be inserted into the optimization Macro automatically. See **APPENDIX: Optimization Introduction** to learn more about the Ready-made Merit Function.

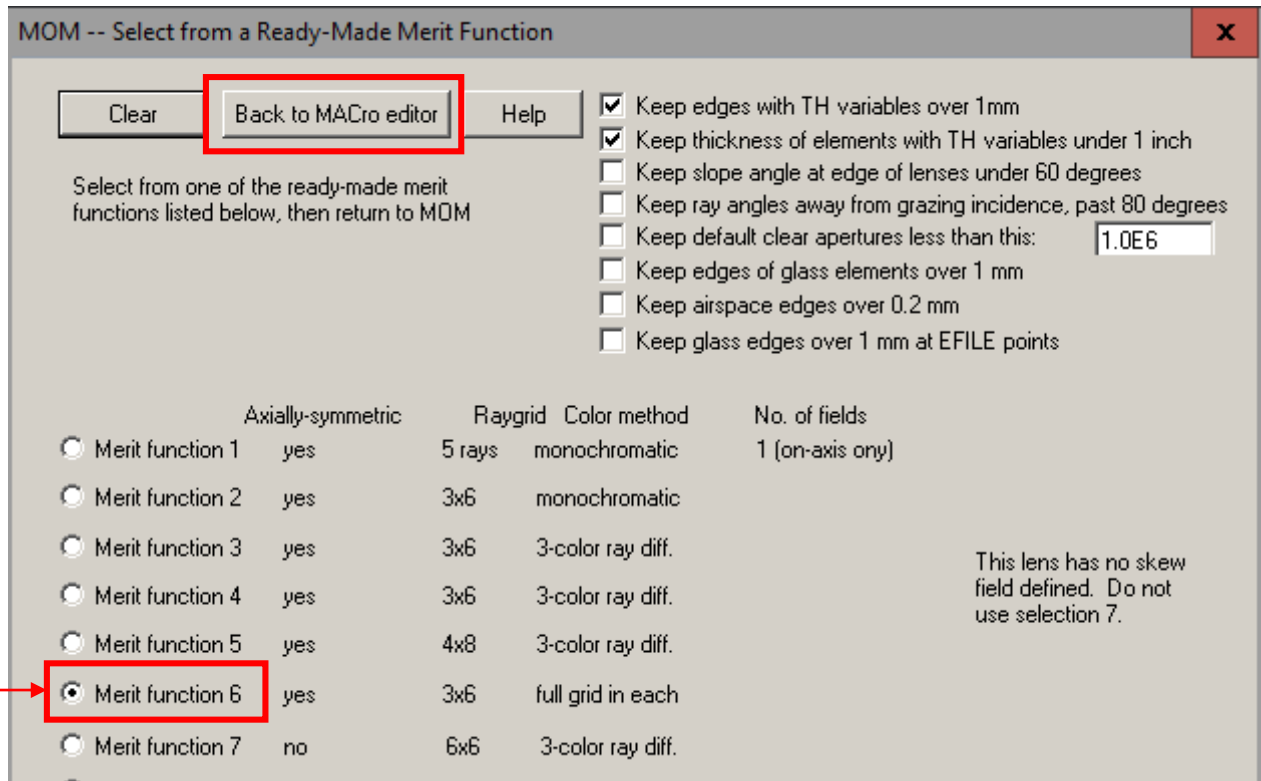

	Axially-symmetric	Raygrid	Color method	No. of fields
<input type="radio"/> Merit function 1	yes	5 rays	monochromatic	1 (on-axis only)
<input type="radio"/> Merit function 2	yes	3x6	monochromatic	
<input type="radio"/> Merit function 3	yes	3x6	3-color ray diff.	
<input type="radio"/> Merit function 4	yes	3x6	3-color ray diff.	
<input type="radio"/> Merit function 5	yes	4x8	3-color ray diff.	
<input checked="" type="radio"/> Merit function 6	yes	3x6	full grid in each	
<input type="radio"/> Merit function 7	no	6x6	3-color ray diff.	

This lens has no skew field defined. Do not use selection 7.

Here's your MACro now:

```

PANT
VLIST RAD ALL
END

AANT
M 100 1 A FOCL
AEC
ACC
GSR .5 10 5 M 0
GNR .5 2 3 M .7
GNR .5 1 3 M 1
END

SNAP
SYNOPTSYS 40
    
```

Commands inserted by Merit Function 6:

- AEC, automatic edge control
- ACC, automatic center TH control
- ray-grid definitions (on-axis GSR, GNR at 0.7 field and full field). These ray grids are often used as a good starting merit function. For more sophisticated control, you can specify individual rays.

Below is a brief explanation to the GSR and GNR commands. (For a more detailed discussion of the optimization input (AANT) file, see **APPENDIX: Optimization Introduction.**)

```
GSR .5 10 5 M 0
```

- Generate 1D sagittal rays,
- With RT (pupil weighting factor) .5
- Weighting factor to merit function = 10
- With a ray grid number of 5
- For all the color (multiple color) in the system
- For on-axis field (field 0)

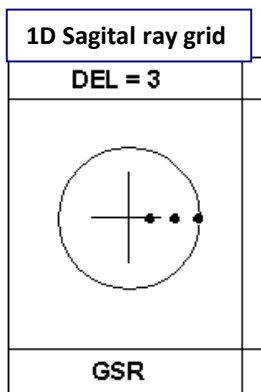

```
GNR .5 2 3 M .7
GNR .5 1 3 M 1
```

- Generate 2D raysets,
- With RT (pupil weighting factor) .5
- Weighting factor to merit function weight 2 for 0.7 field, first line weight 1 for edge field. 2<sup>nd</sup> line
- Ray grid number of 3
- For all the color (multiple color) in the system
- For 0.7 field and the edge

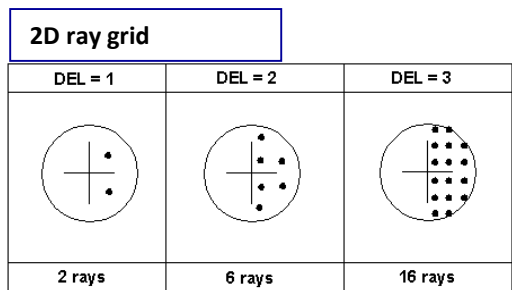

```
AEC
ACC
```

AEC and ACC are optimization monitors that are used to monitor certain aspects of the lens to keep it from becoming unreasonable.

- AEC to monitor edge thicknesses, where TH is varying. A penalty is issued if any of the edge become thinner than **TAR**

```
AEC [ TAR WT [ WINDOW ] ]
```

- ACC activates a control to prevent thicknesses becoming larger than **TAR**,

```
ACC [ TAR WT [ WINDOW ] ]
```

# Ex1.2 Improve the Singlet by Adding an Element

Some more edits to the optimization macro:

```
LOG      ! LOG command for keeping track of your designs
STO 9    ! keep a safety copy in library location 9 just in case

PANT
VLIST RAD ALL
VLIST GLM 1 3 !vary glass models on surfaces 1 and 3
END

AANT
M 100 1 A FOCL
AEC
ACC
GSR .5 10 5 M 0
GSR .5 2 3 M .7
GSR .5 1 3 M 1
END

SNAP
SYNOPSISYS 40
```

Now, Click the Checkpoint button in the SketchPad to keep a copy of the current system before running the optimization.

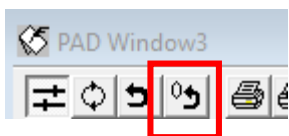

This is the system after optimization:

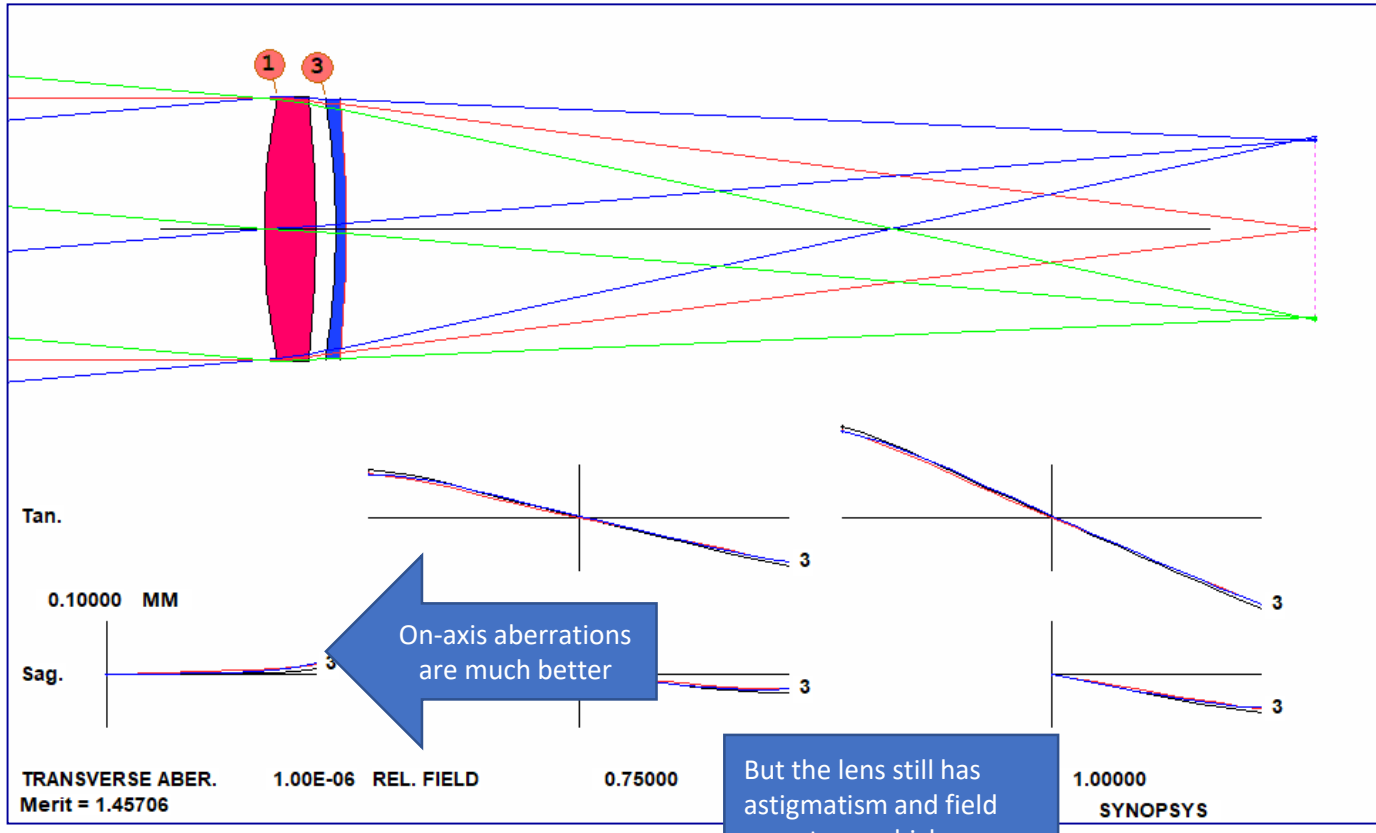



## Exercise 2: A Five Element System Design

## Example 2: A Five Element System Design

Now we'll do a more complex design:

- Five elements
- FOCL 150 mm
- F/3.5
- Semi field 14 degrees
- BACK focus distance 16 mm
- TOTL length 250 mm.
- Visible light
- Aperture diameter =  $150/3.5$ , so paraxial marginal ray height at the first element (YMP1) is 21.42 mm.

How does one approach this kind of problem? Some possible approaches:

1. Search a patent database
2. Look in your file of previous designs
3. Do a third-order design by hand
4. Play it by ear
5. Let the computer do the work.

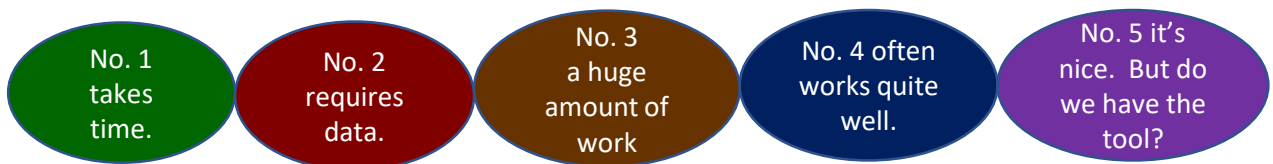

**Let's say we'll start with option 4:  
enter lens data based on intuition.**

- First, a sketch:

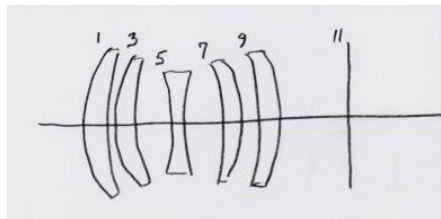

- Then *Guess* values for radii, thickness, and glass index.

# Ex2.1 Design by Experience (or Wild Guess)

Here's a wild guess:

Enter these data into the MACro editor and click the Run button.

```

RLE
ID PLAY IT BY EAR
OBB 0 14 21.42
UNI MM
WAVL CDF
APS 5
1 RD 100 TH 5 GLM 1.6 60
2 RD 200 TH 3
3 RD 50 TH 5 GLM 1.6 60
4 RD 100 TH 8
5 RD -200 TH 3 GLM 1.6 40
6 RD 100 TH 8
7 RD -100 TH 5 GLM 1.6 40
8 RD -50 TH 3
9 RD -200 TH 5 GLM 1.6 40
10 RD -100 YMT
11
END
    
```

Object format B:  
 OUPP = Marginal ray angle coming in (0)  
 OUPP = Chief ray angle coming in (14)  
 YMP1 = Marginal ray height (21.42)

Glass model (GLM) on all elements (index and V-number)

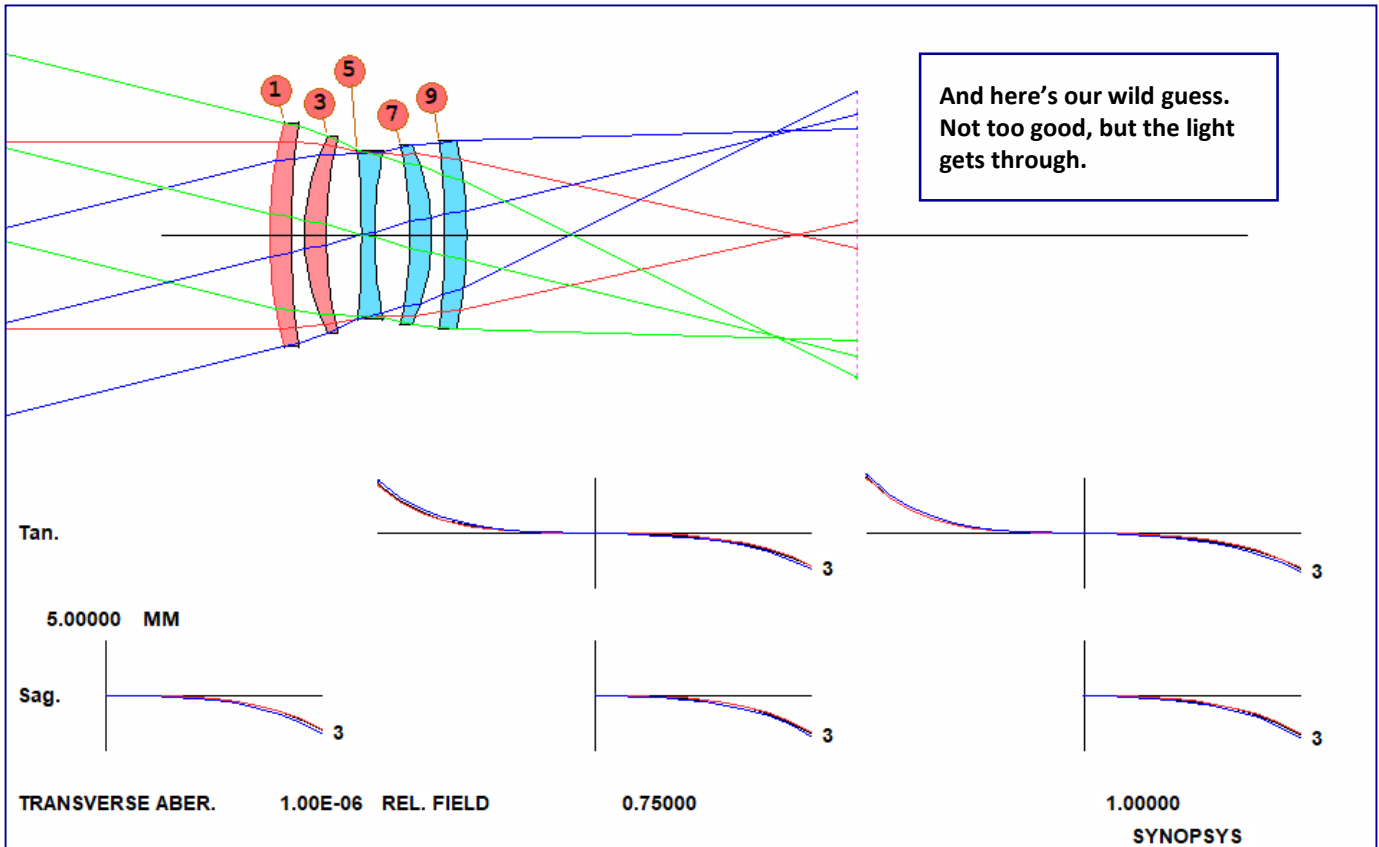
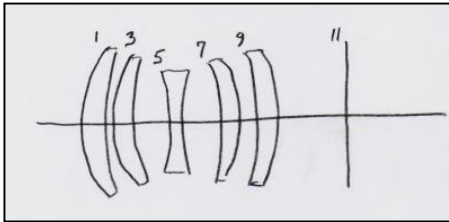

Optimization:

First, open a new macro editor by clicking at the 'new macro editor' button at SYNOPSIS™ workspace top toolbar:



Type the following commands into the new MACro editor.

```
LOG
STORE 9
PANT
VLIST RAD ALL
VLIST TH ALL
VLIST GLM ALL
END
```

```
AANT
M 150 1 A FOCL
M 16 1 A BACK
LUL 250 1 1 A TOTL
END
```

```
SNAP
SYNO 30
```

This is a one-sided aberration, so the total length can get smaller, but not larger than, 250. For more information, see APPENDIX Optimization introduction

Put the cursor right here.

And then click the 'Ready Made Raysets (Merit Function)' button in the Macro Editor to open the Select Merit Function dialogue to see a list of handy merit functions



Select Merit Function 6 and then click at the 'Back to MACro editor' to insert the command block into your macro.

Here is the complete optimization macro with the Ready-Made Merit Function inserted.

```
LOG
STORE 9
PANT
VLIST RAD ALL
VLIST TH ALL
VLIST GLM ALL
END
```

```
AANT
M 150 1 A FOCL
M 16 1 A BACK
LUL 250 1 1 A TOTL
AEC
ACC
GSR .5 10 5 M 0
GSR .5 2 3 M .7
GSR .5 1 3 M 1
END
```

```
SNAP
SYNO 30
```

Run the MACro, and the lens is much improved.

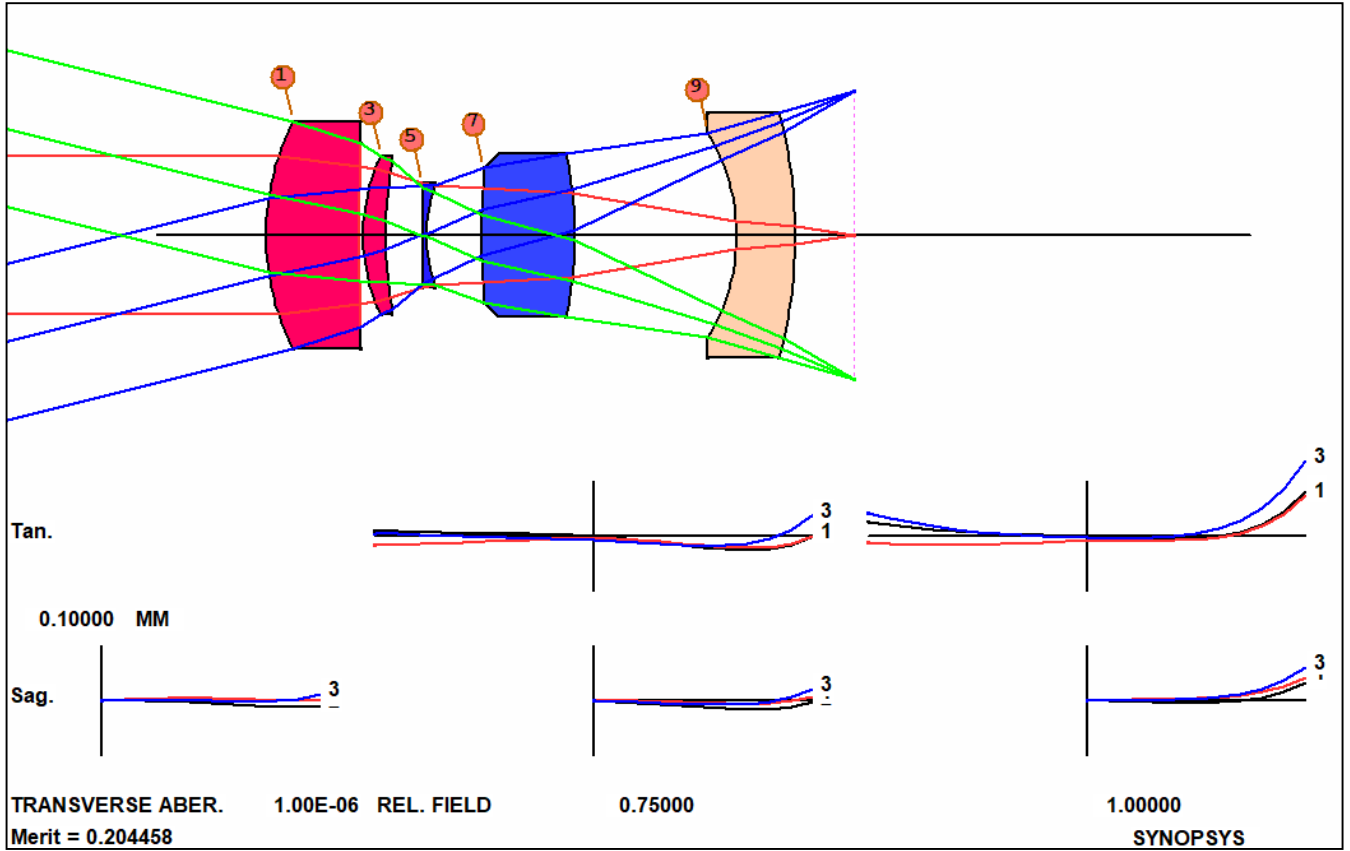

Now, let's do simulated annealing to the lens. During the optimization process, Lenses often get stuck in a local minimum. Annealing can help the system jump out of the local minimum and go on to find the lower one. When the lens is annealed, the program makes a series of small random changes to the design variables and reoptimizes, over and over.

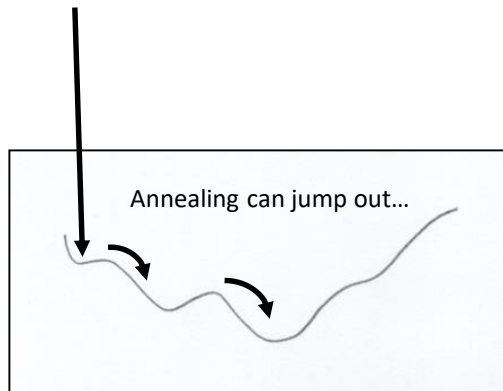

... and find the lowest minimum.

### Ex2.1 Design by Experience (or Wild Guess)

To start the anneal process, click the anneal button in the top toolbar to open the anneal dialog. Input the anneal parameter as shown below. Click OK to start the process.

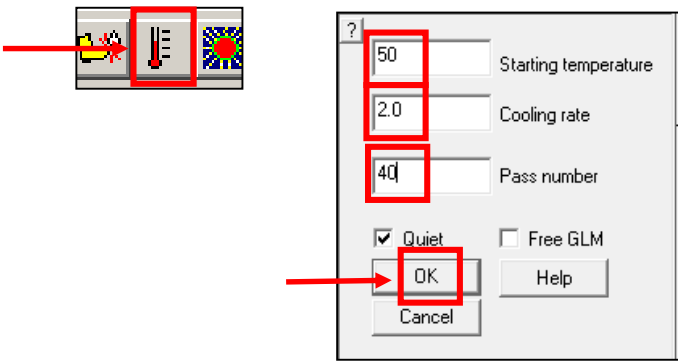

Now the lens is much better, but the edge of the field has poor color correction.

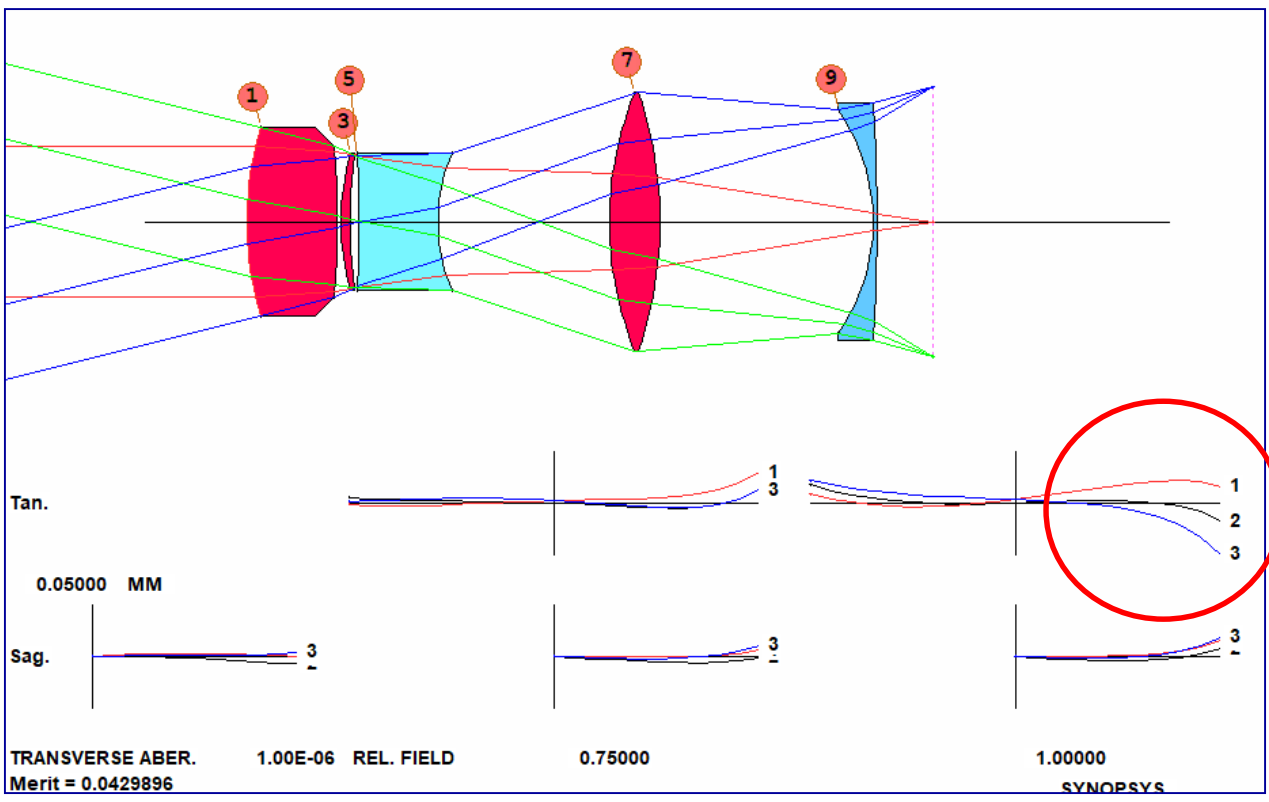

### Ex2.1 Design by Experience (or Wild Guess)

Lens design is mostly about modifying the merit function to better control whatever is the worst problem at the moment. Because we saw that in the last page that the lens has poor color correction at the edge of the field. We try to correct it by re-optimizing the lens:

```
LOG
STORE 9
PANT
VLIST RAD ALL
VLIST TH ALL
VLIST GLM ALL
END

AANT
M 150 1 A FOCL
M 16 1 A BACK
LUL 250 1 1 A TOTL
AEC
ACC
GSR .5 10 5 M 0
GSR .5 2 3 M .7
GSR .5 4 3 M 1

END

SNAP
SYNO 30
```

Increase the weight on the rays at the edge of the field from 1 to 4 and run the MACro again.

As a good practice, make a checkpoint between optimization stages. The lens is further improved with this optimization.

Not bad! And this is from a wild-guess starting point.

But there is some knowledge there too:

- The stop was in the middle to gain some symmetry advantage.
- The lenses were bent the way that minimized SA3.

It's not just a wild-guess after all.

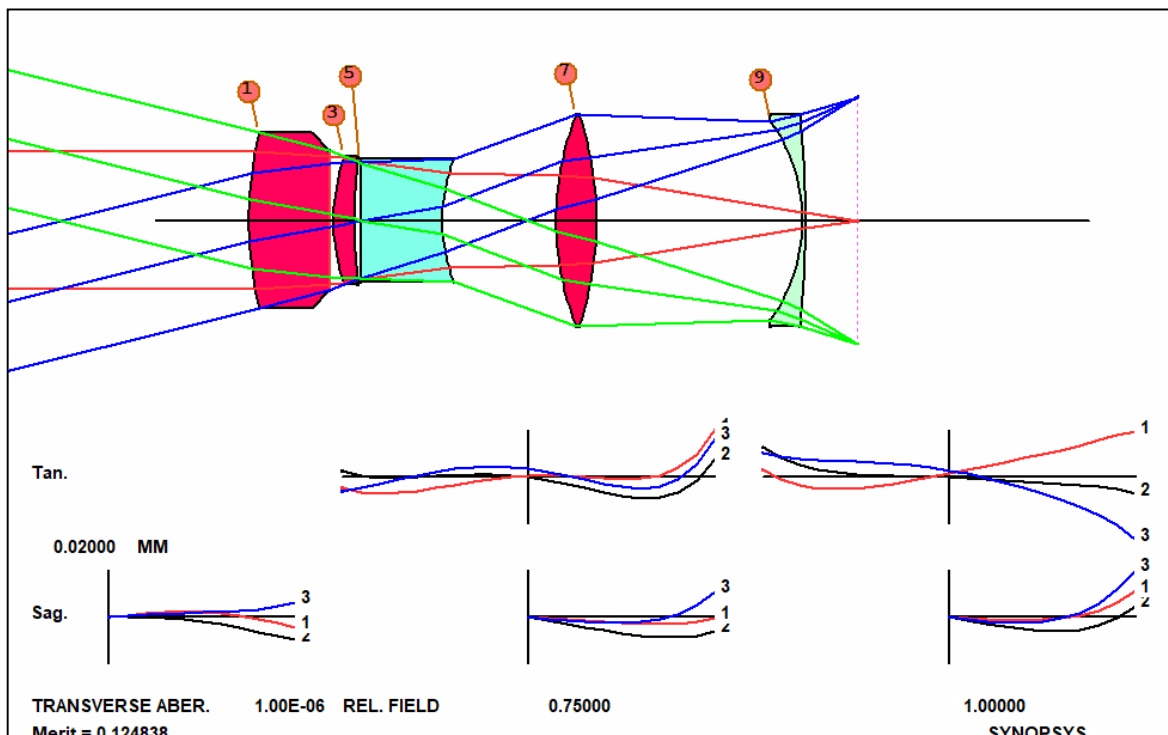

Now we'll demonstrate how to use another important tool in SYNOPSIS™, DSEARCH™, to do this problem. With the newer design tools made available by innovative algorithms, you can make system-level decisions, but let the program work out the details.

The DSEARCH (Design Search) in SYNOPSIS™ is an Automatic Design tool created to provide an effective, fast, and practical solution for optical design. It is created

1. To ease the burdens on the designers in finding good starting points for their design projects.
2. To explore the design space efficiently to discover alternative design forms that may deliver better performances

The principle behind it can be visualized easily using the analogy of skiing down the mountain top to find the valleys:

- From the top of a mountain you can see all the valleys.
- To search for the lower valleys, send out multiple probes that descend from the mountain top in different directions.

Because the search is not limited to the vicinity of a pre-select starting point (as in the traditional approach), this method is also referred to as the Global Search method.

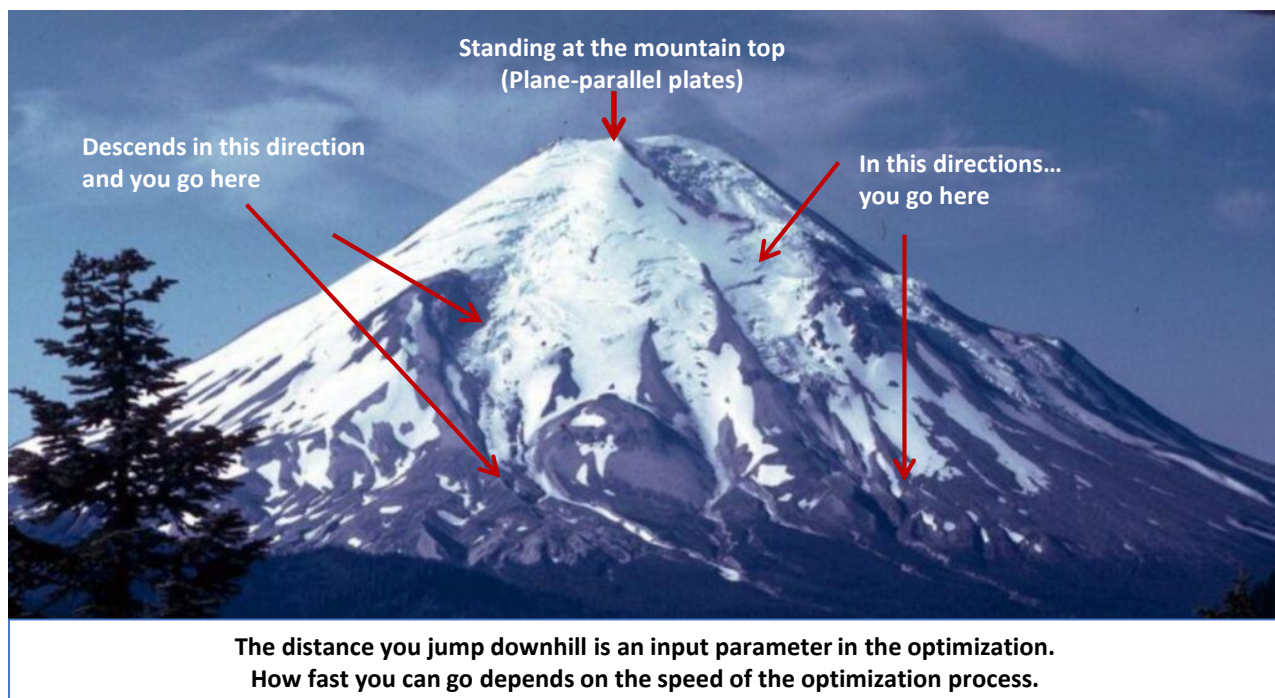



Type **MDS** (Menu, Design Search) to open the Design Search Menu and fill in data as shown below.

Then click OK. Name the file DSEARCH\_5.MAC when asked for a filename.

MDS -- Design Search, MSP -- Saddle-Point Build

With this dialog you can create a family of lenses. Fill out the items below and click OK. You'll be asked for a filename; then run the file.

DSEARCH Library location  The library location must be from 1 to 10; the best result will be stored there.  Design Search  Saddle-point build  Use current

SPBUILD   QUIET mode

**SYSTEM**

ID  5 ELEMENT DSEARCH Enter the lens identification.

WAVL  0.6563  0.5876  0.4861 Enter 3 wavelengths: long, middle, short, in um

Object at infinity  
 Object at this distance: -->  (TH0)

14 Object angle (or height if finite) (UPPO or YPP0)

21.42 Semi-diameter of axial entering light beam (YMP1)

Units MM  
 Units inches

Lens is focal  
 Lens is AFOCAL

Enter any special system requirements here, such as WAP selection.

**SPECIAL PANT**

Enter any special variable requests, in PANT format.

**SPECIAL AANT**

Enter any special aberrations to be controlled, in AANT format.

**GOALS**

Leave blank any fields you do not care about, except number of elements, and FNUM if focal.

ELEMENTS  5 Desired number of elements

FNUM  3.5  Target value, weight

BACK  16  .1 Target value, weight

TOTL  250  .1 Target value, weight  
 (Enter target of zero to bypass BACK or TOTL)

FOV  0.0  0.75  1.0  0.0  0.0

FWT  5.0  3.0  1.0  1.0  1.0

RSTART  500

STOP first THSTART  7 Thicknesses  
 STOP middle ASTART  7 Airspaces  
 STOP last  
 STOP telecentric  3-COLORS  
 Major color only  
 All COLORS

STOP free to move

Passes: quick, real  
 Quick Mode  30  40

Aperture-dependent weight  0.5

Binary search  
 Random search, cycles =  200

TRACK monitor progress  
 REVERT to quick mode start  
 OPD correct OPDs instead of transverse ray coordinates  
 SAMPLE generate a single sample

NPASS  10 Number of optimization passes

ANNEAL  200  20  Q Temperature, cooling

Passes  
 SNAPSHOT  10

OK  Cancel  Help

You really should read the Help file before you run these features. Click the Help button if you have not.  
 There are other advanced features, not found in this dialog, which you can read about in the manual.

MDS creates a MACro for you, with all of the input required to run DSEARCH™.

```
CORE 8
DSEARCH 5 QUIET
SYSTEM
ID 5 ELEMENT DSEARCH
OBB 0 14 21.42
WAVL 0.6563 0.5876 0.4861
UNITS MM
END

GOALS
ELEMENTS 5
FNUM 3.5
BACK 16 .1
TOTL 250 .1
STOP MIDDLE
STOP FREE
RSTART 500
THSTART 7
ASTART 7
RT 0.5
FOV 0.0 0.75 1.0 0.0 0.0
FWT 5.0 3.0 1.0 1.0 1.0
NPASS 10
ANNEAL 200 20 Q
COLORS 3
SNAPSHOT 10
QUICK 30 40
END

SPECIAL PANT

END

GO
```

If you have a multicore PC, add a **CORE** command at the top.

Run this MACro.

DSEARCH comes back with 10 potential designs. Usually the top one is the best – but not always. You are encouraged to try the others too to explore the design space. Each one has a merit value and a filename.

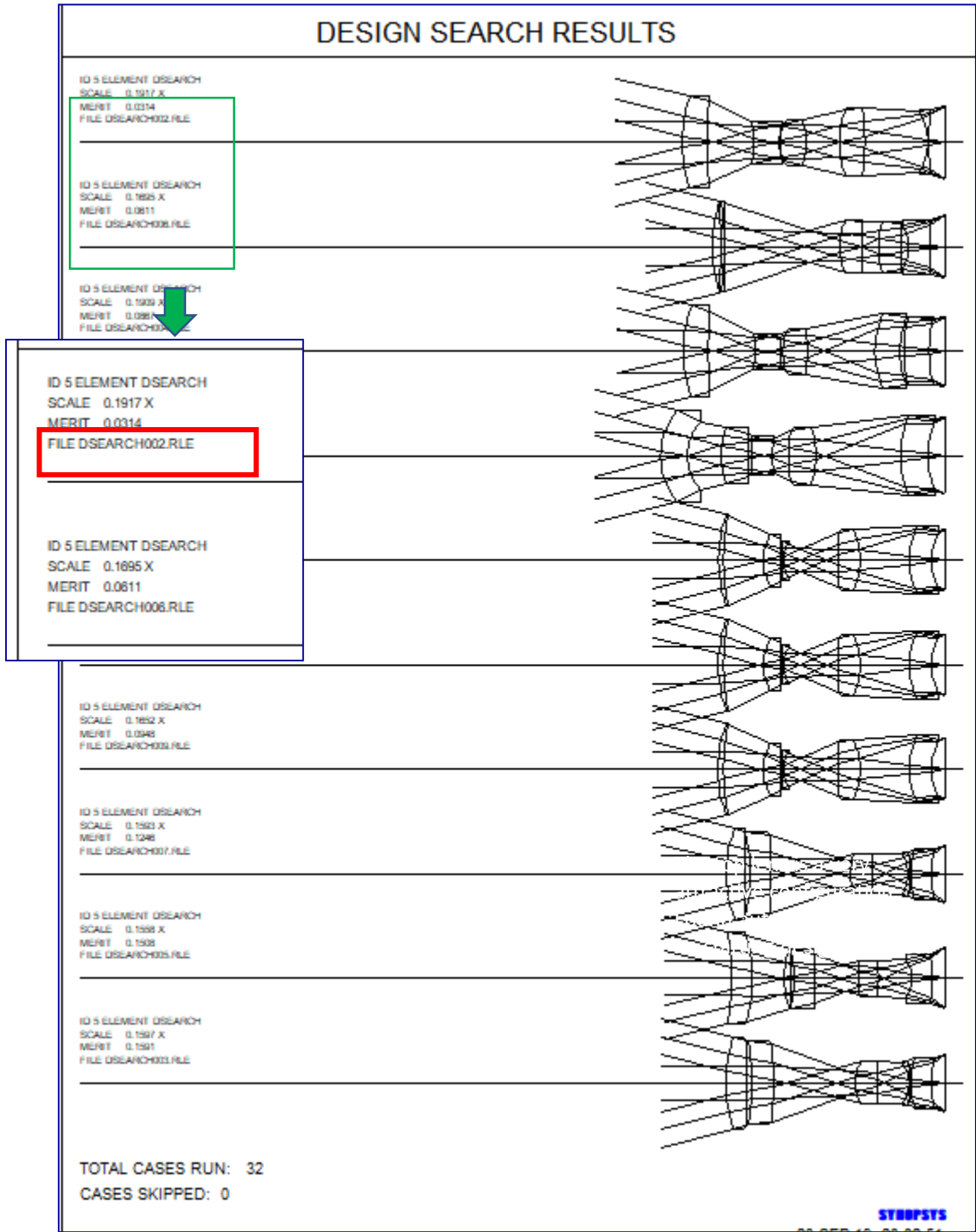

If you want to read the ranking of the ten best lenses and their filenames, open the macro DSS.MAC that is automatically generated by DSEARCH. You can also run the macro by typing the Execute Macro command: **EM DSS.MAC**. SYNOPSYS™ will cycle through each lens at the click of the 'return' key. The filename is displayed at the upper left corner of the SYNOPSYS™ workspace window:

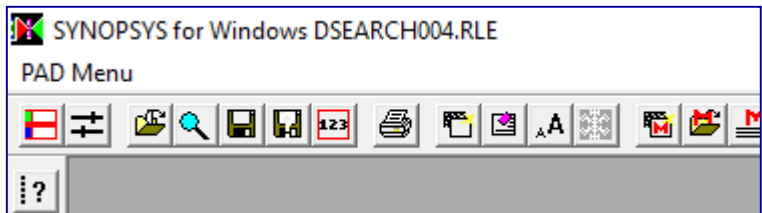

## Ex2.2 Design by DSEARCH

In this demo, we use the top lens returned by DSEARCH. You can select the 2<sup>nd</sup> best to see how it goes, for the sake of exploring the design space. If you are going to use the top lens from DSEARCH, you don't need to do anything to launch the lens file. It's already launched. If you want to use another file, say the 2<sup>nd</sup> best, according to the list returned by DSEARCH (see last page), it would be DSEARCH006.rle. So you can type in the command `FETCH DSEARCH006` to launch it.

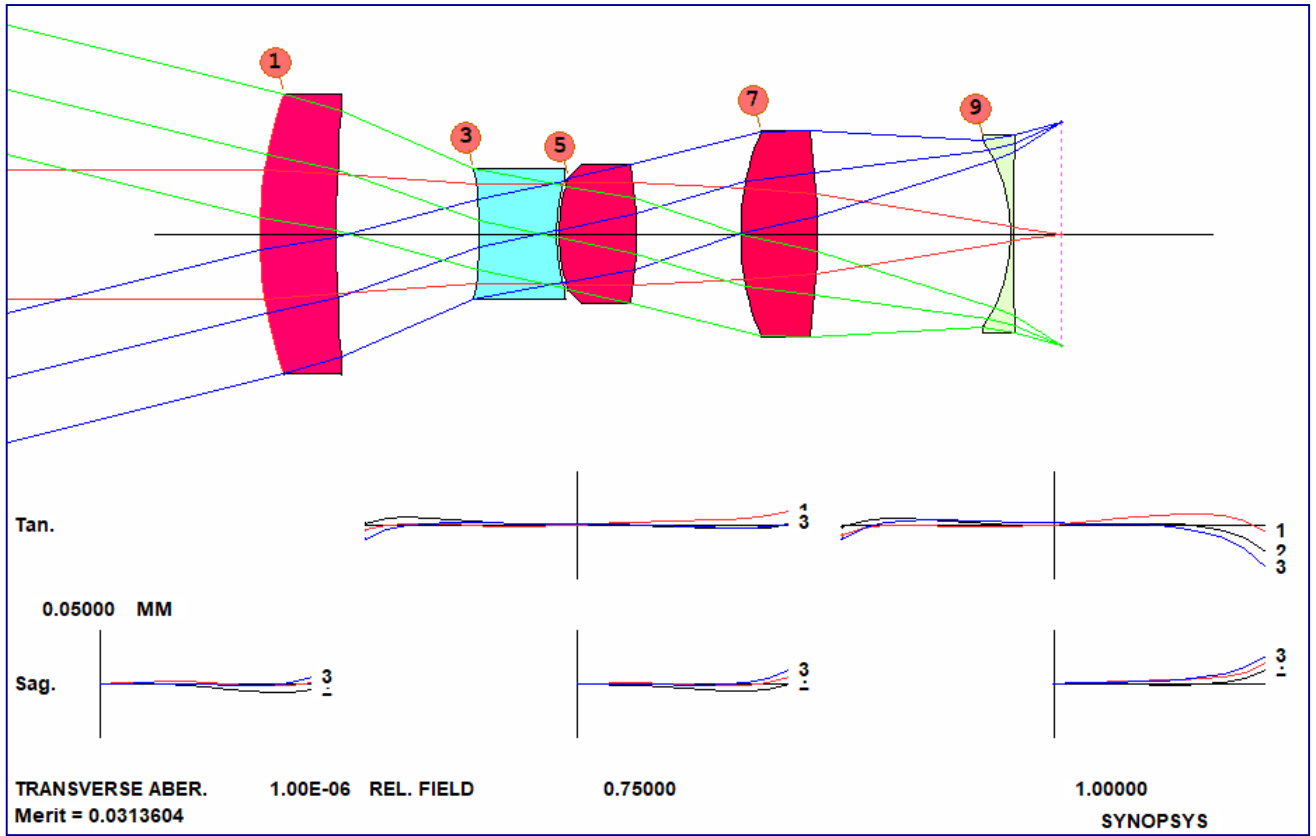

DSEARCH also generates an optimization macro for you to further refine the lens:

```

PANT
VY 0 YP1
VLIST RD ALL
VLIST TH ALL
VLIST GLM ALL
END
AANT P
AEC 3 1 1
ACM 3 1 1
ACC
GSR 0.500000 5.000000 4 1 0.000000
GSR 0.500000 5.000000 4 2 0.000000
GSR 0.500000 5.000000 4 3 0.000000
GNR 0.500000 3.000000 4 1 0.750000
GNR 0.500000 3.000000 4 2 0.750000
GNR 0.500000 3.000000 4 3 0.750000
GNR 0.500000 3.000000 4 1 1.000000
GNR 0.500000 3.000000 4 2 1.000000
GNR 0.500000 3.000000 4 3 1.000000M
0.160000E+02 0.100000E+00 A BACK
M 0.250000E+03 0.100000E+00 A TOTL
END
SNAP/DAMP 1
SYNOPTSYS 40
    
```

Because there are some thin edges and centers in the lens, we increase the weighting of the AED and ACM as shown in red.

The edge of the field needs a higher weight too.

Run the macro to optimize the lens and then anneal it.

This lens is quite different from the previous design, where we guessed a starting point.

It illustrates a basic truth: for a complex lens, there are many configurations that have roughly equal quality.

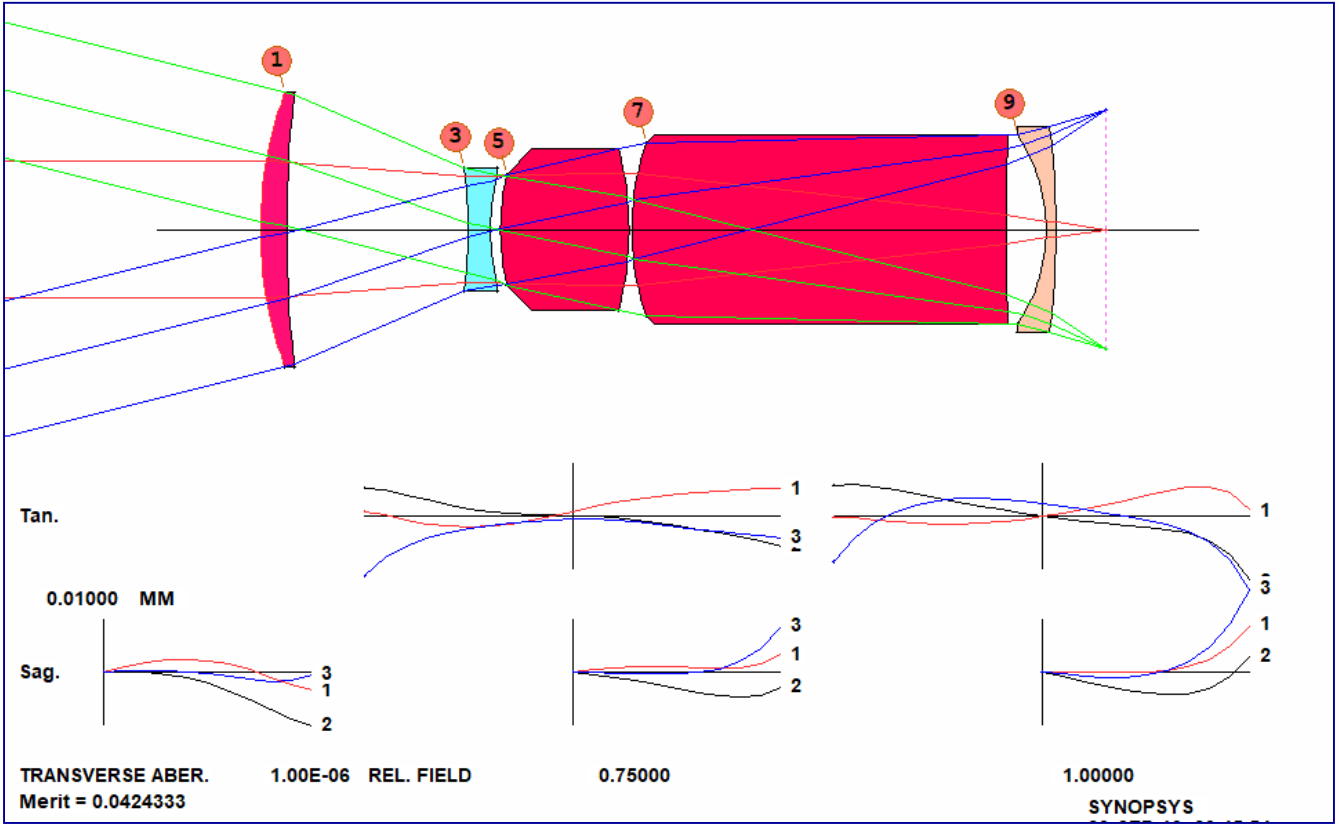

One more step: The lens has model glass types. We need to substitute real glasses for them. Type MRG to open the 'Automatic real glass insertion' dialog. Make the selections shown, and click OK.

Note: MRG has to be run *immediately* after a normal optimization. (It uses the same variables and merit function.)

```

--- ARGLASS 6 QUIET
Lens number      6 ID 5 ELEMENT DSEARCH
GLASS S-FPM3     HAS BEEN ASSIGNED TO SURFACE 5; MERIT = 0.163008
GLASS S-LAL18    HAS BEEN ASSIGNED TO SURFACE 1; MERIT = 0.155760
GLASS S-LAH59    HAS BEEN ASSIGNED TO SURFACE 7; MERIT = 0.152378
GLASS S-LAH71    HAS BEEN ASSIGNED TO SURFACE 3; MERIT = 0.146339
GLASS S-TIH6     HAS BEEN ASSIGNED TO SURFACE 9; MERIT = 0.170617
Type <ENTER> to return to dialog.

```

And here's our lens. This is about as good as one can do with five elements to these specifications.

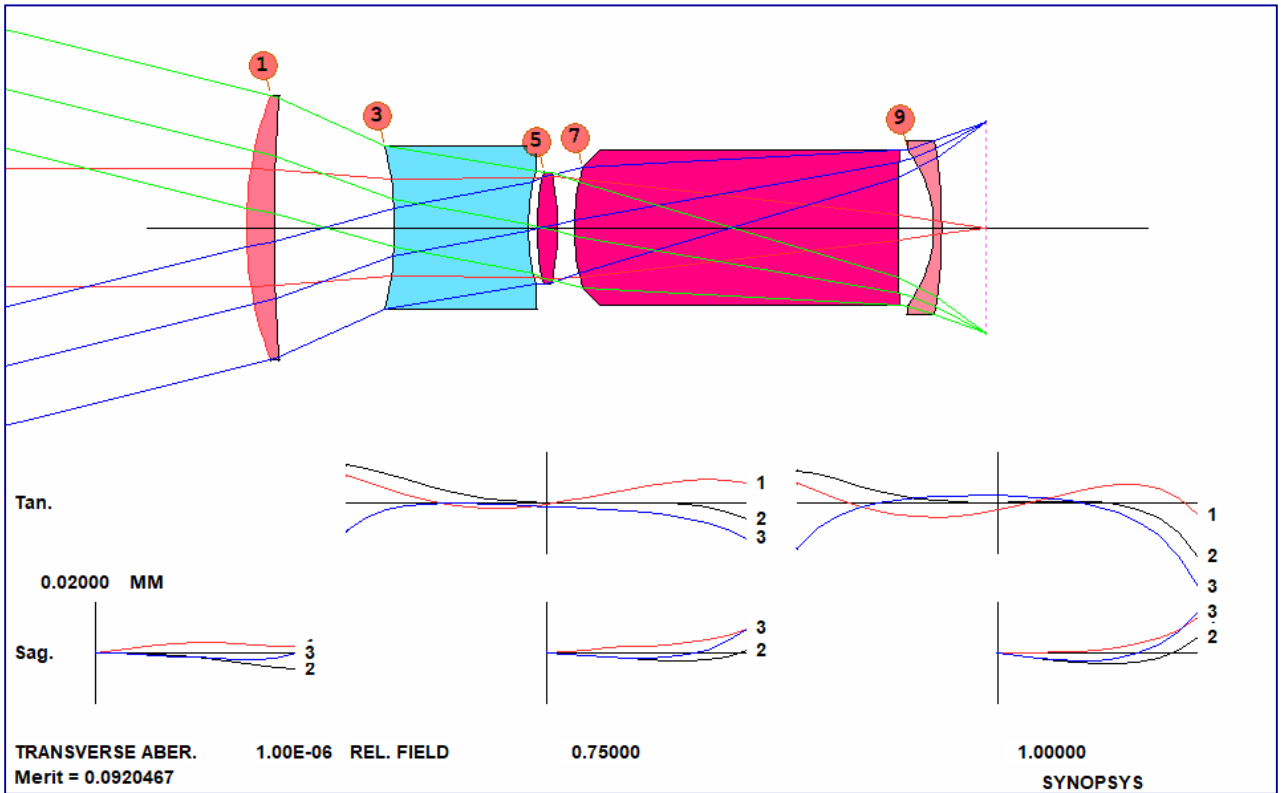

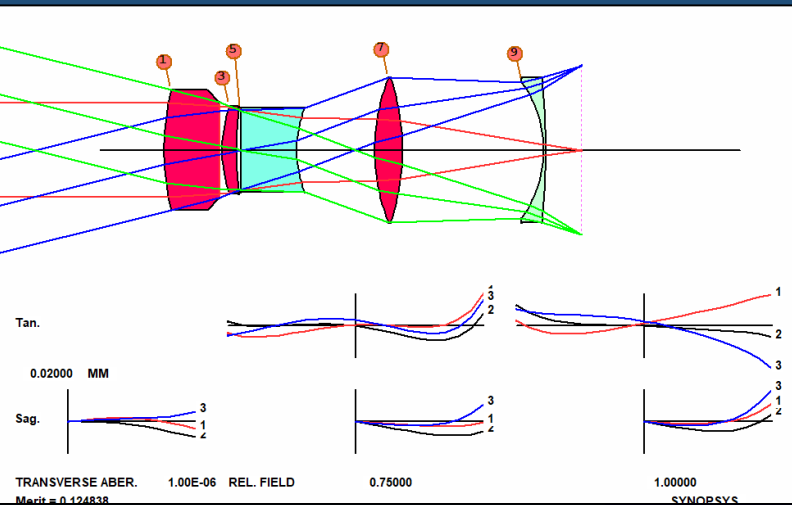

Two potential solutions.

In only a few minutes.

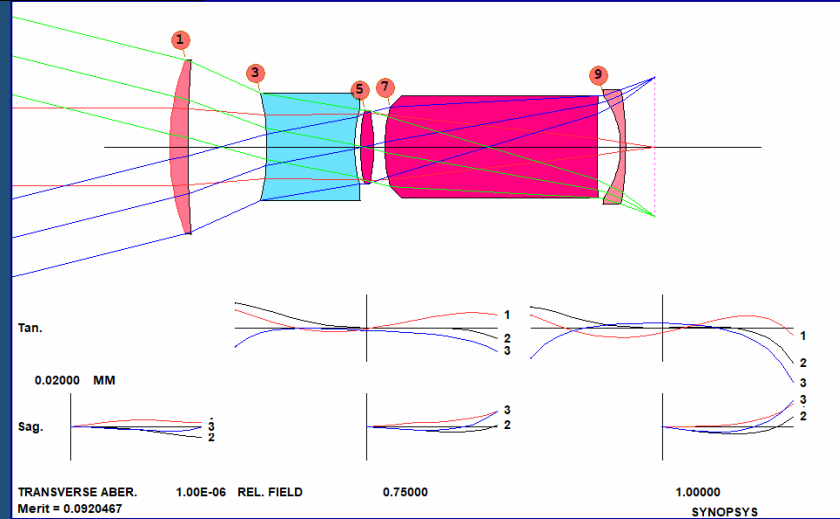

That is a brief introduction in how to use the SYNOPSIS™ lens design software.

- Knowledge of optics theory never hurts.
- But the computer does most of the work.
- It can often find solutions that a 3<sup>rd</sup>-order study cannot.



# APPENDICES

# APPENDIX: Macro Files

To read more about the Macros in SYNOPSIS™, type macro in the Help menu to search for the Macros page:

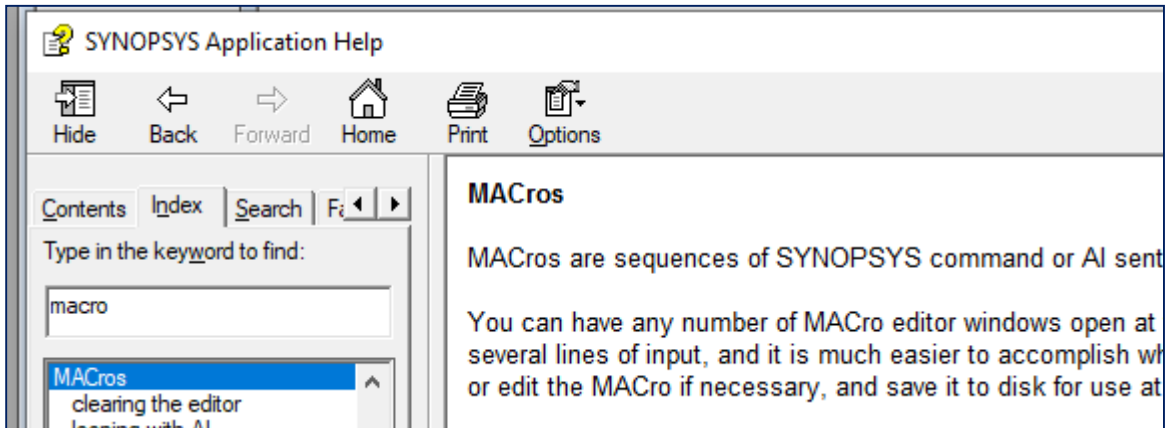

In that page, you will find the description of the macro toolbar buttons:

MACro editor Toolbar:



Saves the MACro file with the most recent name and runs it.



Opens a named MACro.



Opens a dialog where you can select from a saved MACro file.



Saves the MACro file, prompting for a new name.



Saves the MACro with a name equal to the current log number. This does not rename the MACro itself, but only saves a copy with the numeric name. This feature is intended to help you document your lenses. The button appears in two places, on the main window toolbar and on the MACro editor toolbar. When you have run the optimization program and get a lens that you want to save, click on that button in both places. Now you have an RLE file and a MAC file with the same name, making it easy to see how you got there. If you have also run [BTOL](#), the command BTOL SAVE will save a copy of the tolerance budget with the same name and a file type .BTO. This is how you can create a complete record of your work.



Opens a new MACro window. You can have any number open at a time.



Erases the contents of the current editor.



Renames the MACro DEFAULT.MAC. This is useful if you want to make a change and run it without replacing the original MACro on disk.

## And some commands relating to the manipulation of the Macro files :

The command **LM filename** (Load MACro) will load the named MACro file into an editor. This will use the most recently opened editor window, if any, or a new one if there are none.

The command **LAM filename** (Load Alternate MACro) will load the named MACro file into a new editor window. This will not alter any other editor windows that may be open.

The command **EM filename** (Execute MACro) will immediately execute the named MACro without opening an editor.

The command **EAM filename** (Execute Alternate MACro) will immediately execute the named MACro without opening an editor. This form uses the alternate memory, which leaves intact the main MACro memory. Its main use is within a MACro, to permit that MACro to call another as a subroutine so that control will return when the other has finished. Placing an EM command inside a MACro (instead of EAM) would execute (and overwrite) that MACro, and would not then return.

The command **LMM** (Load Menu MACro) will load the MACro editor with the commands that duplicate the most recent action performed by a dialog. This makes it easy to create a MACro that will do what you last did via the dialog. Then you can execute or save that MACro, giving you a convenient way to do that particular task again.

# APPENDIX: Using Spreadsheet in SYNOPSIS™ to enter lens data

This appendix demonstrate how to enter the singlet lens data using the SYNOPSIS™ spreadsheet.

In the Command Window, type SPS at the prompt to open the SpreadSheet:

**SYNOPSIS AI> SPS**

You can also open with the SpreadSheet button on the top toolbar:



SPS -- SYNOPSIS SpreadSheet

Surface Types: S Spherical, C Conic section, F Flat, Z Zernike, B biconic, T Toric, H HDE or DOE

Glass Types: G Grating, L splLine, R biRadial, P Polarizer, O astDric, N Nczone, U USS

S.N.	Surface Flags	Data Flags	Radius	Conic Constant	Thickness	GlassType	N1	N2	N3	N4
0		F	infinite		0		1	1	1	
1		F	infinite		1		1	1	1	
2		F	infinite		0		1	1	1	
3										
4										
5										
6										
7										
8										
9										
10										

Enter data as shown below. So far, only two surfaces exist (plus surface 0 for the object.)

S.N.	Surface Flags	Data Flags	Radius	Conic Constant	Thickness	GlassType	N1
0		F	infinite		0		1
1		S	50		5		1
2		S	-50		0		1
3							
4							

To add a surface:

S.N.	Surface Flags	Radius	Conic Constant	Thickness	GlassType	N1
0	F	infinite		0		1
1	S	50		5		1
2	S	-50		0		1
3						
4						

Click in this box on line 3, and then click the "+" at the top of the SpreadSheet

T Toric N Nczone  
H HOE or DOE U USS

Controlled by GLOBAL, LOCAL, or COINCIDENT on next surface

12345678

12<- Reflecting

Conic Constant Thickness GlassType

	0		
	5		
	0		

Now surface 3 exists. That will be the image surface.

S.N.	Surface Flags	Radius	Conic Constant	Thickness	GlassType	N1
0	F	infinite		0		1
1	S	50		5		1
2	S	-50		0		1
3	F	infinite		0		1
4						

First, we need to enter some system data to define the object, wavelengths for your design, system units, aperture stop, ...etc. To enter System Data, click the System Data button at the top of the spreadsheet:

**Click the System Data button.**

**This opens the System Data Editor that allows you to input data relating to the system set-up such as object definition, system unit, types of pupils, wavelengths, and everything that is not unique to a single surface.**

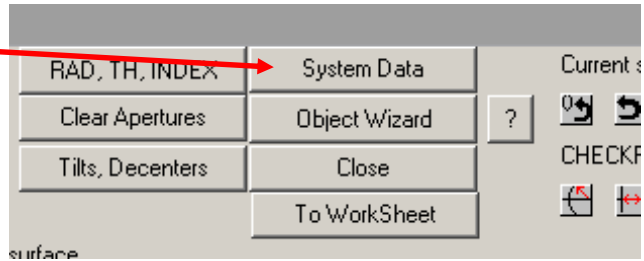

**First, enter the lens ID here to label the lens. This ID will show in the Lens Library as a descriptive label to the lens system.**

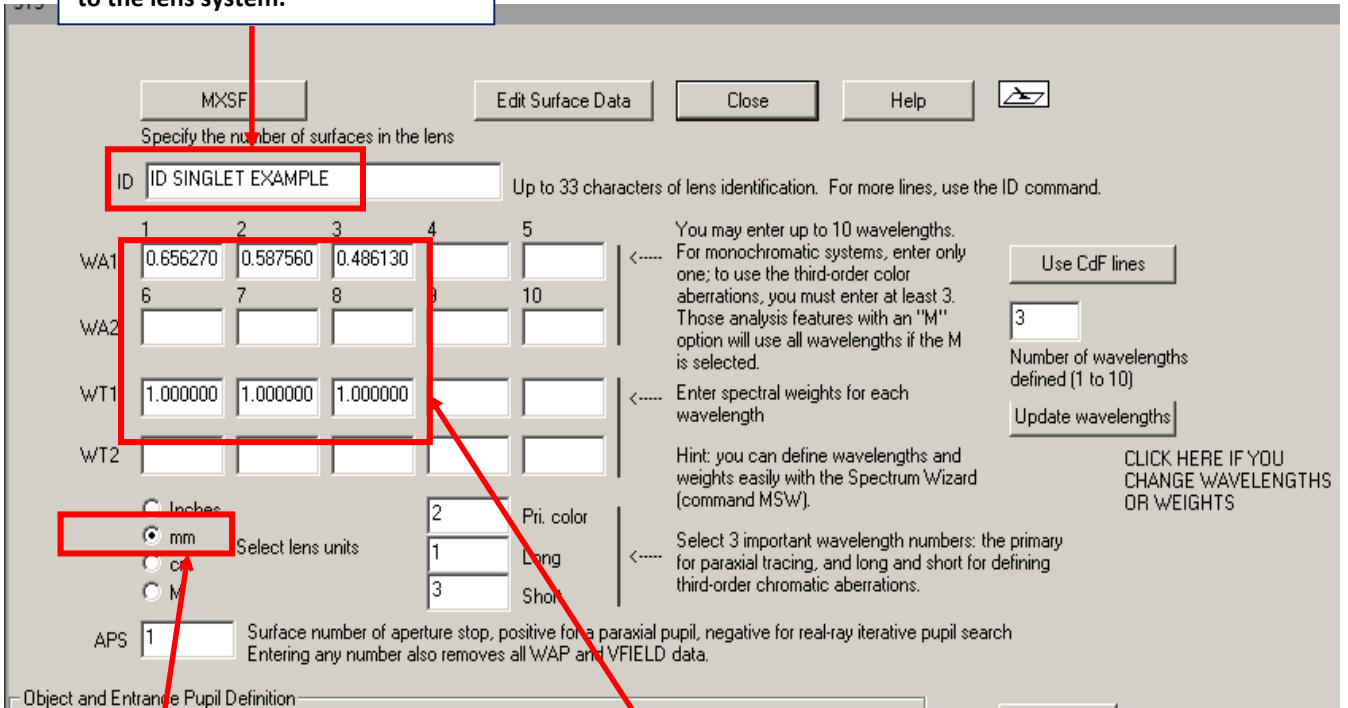

**Select 'mm' as the system unit.**

**Accept the default wavelengths (CdF lines) and corresponding spectrum weights.**

In the same System dialog, enter the following to define an object:

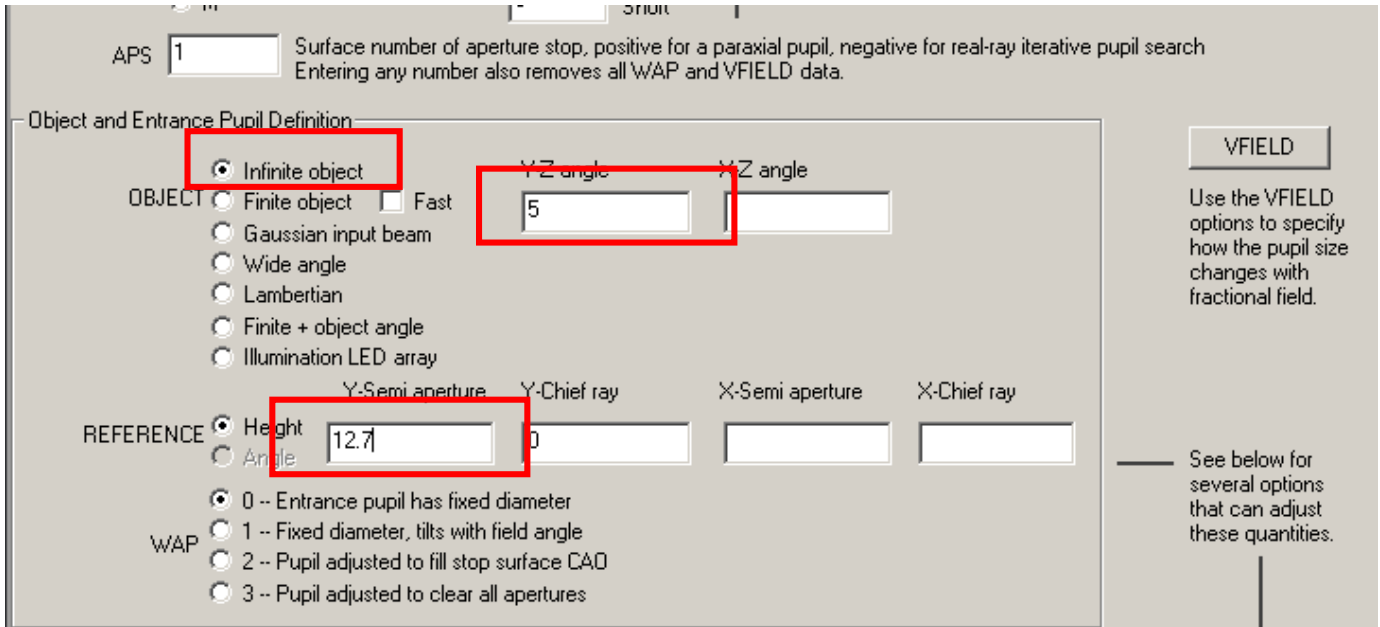

This defines an object at infinity, with a chief ray angle of 5 degrees, and a marginal ray height of 12.7

Then click at 'Edit Surface Data' to go back to the Spreadsheet.

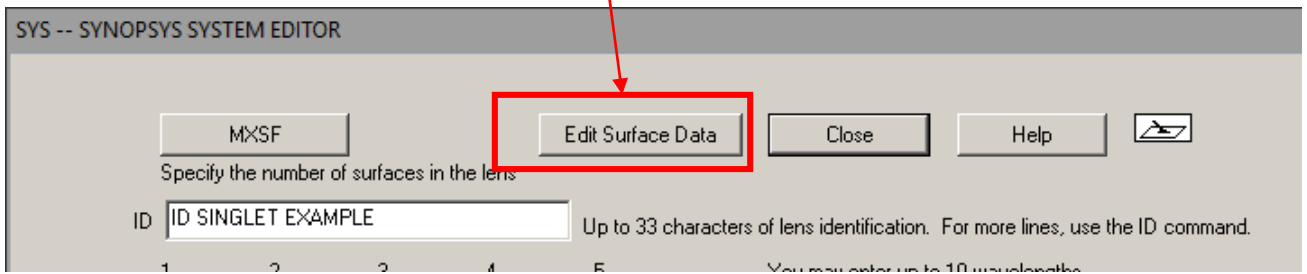

Next, we will demonstrate how to define the Glass type for the surfaces.

In the SpreadSheet:

1. Click here to open the 'Edit Index Options' dialog for surface 1.

Surface	Flags	Radius	Conic Constant	Thickness	GlassType	N1	N2
0	F	infinite		0		1	1
1	S	50		5		1	1
2	S	-50		0		1	1
3	F	infinite		0		1	1
4							
5							

2. Select Glass table option

Index Option, Surface 1

This index is controlled by a solve or lookup.

- Air
- Vacuum
- Explicit indices -->
- Glass table -->
- Glass model -->
- Pickup indices -->
- Interpolation coefficients -->

3. In the Edit Glass Table dialog, select 'Schott'; then enter N-BK7 for the Glass name

Edit Glass Table Selection

Select a Glass Table, enter glass name, click OK

- Schott
- Ohara
- Hoya
- Unusual materials
- Corning France
- Guangming
- LZOS
- Sumita
- Custom

Glass name

Show Catalog

You can also select glass-table glasses with the SketchPAD->GT feature, which shows the selected glass map and lets you click on the glass you want.

OK Cancel Help

Click OK to close the dialog. The glass for surface 1 is updated to N-BK7



Now the glass type is defined. But we have not defined the back-focus distance. We will add an YMT (thickness solve: marginal ray height) to place the image plane at the paraxial focus.

1. Click at the square left to the Thickness column at surface 2 to open the 'Edit Lens Thickness or Airspace' dialog in order to solve for distance to the following surface, which is the image plane.

S.N.	Surface Flags	Data Flags	Radius	Conic Constant	Thickness	GlassType	N1
0		F	infinite		0		1
1		S	50		5	N-BK7	1.51432
2		S	-50		0		1
3		F	infinite		0		1
4							

2. Select 'Edit Solves' in the Thickness dialog.

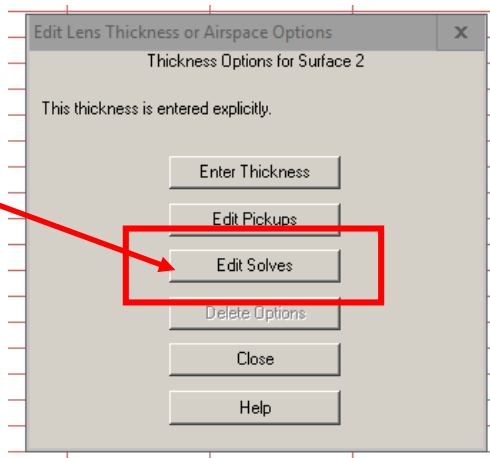

3. In the 'Edit Thickness Solve' dialog, select YMT solve

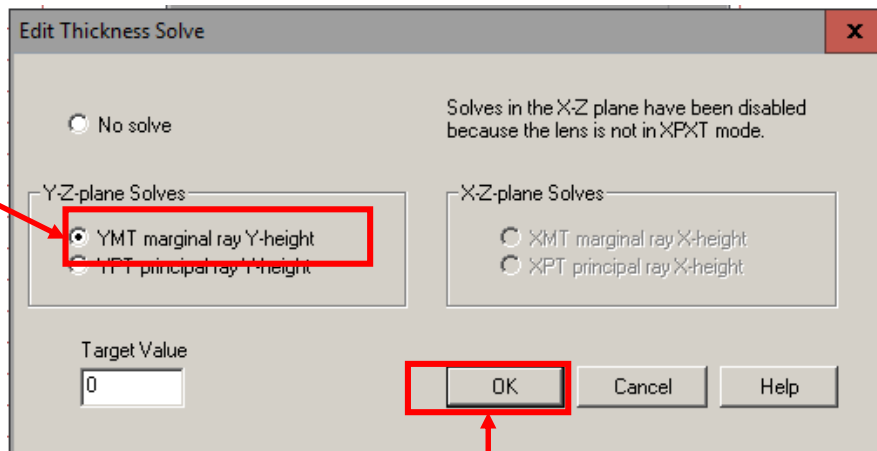

4. Click OK and then Close.

When we select the YMT solve, SYNOPSIS™ finds the thickness (T) such that the height (Y) of the marginal paraxial ray (M) will be the requested value (zero) at the next surface. In other words, surface 3 will be at the paraxial focus. This is an example of **paraxial solve**.

With the thickness solve in place, the distance between the back surface of the singlet and the image plane is set to be 47.536738.

Now the singlet lens is fully defined.

S.N.	Flags	Radius	Conic Constant	Thickness	GlassType	N1	N2	N3	N4	N5	N6	N7	N8
0	F	infinite		0		1	1	1					
1	S	50		5	N-BK7	1.51432	1.51679	1.52237					
2	S	-50		47.536738		1	1	1					
3	F	infinite		0		1	1	1					
4													
5													
6													
7													
8													
9													
10													
11													
12													

Lens Preview

Surfaces 1 thru 999

Y-Z profile

Perspective Drawing

ElevationAzimuth

Draw Circular Rims

# APPENDIX

## Singlet Lens Data File Commands Explained

Lens data file for the singlet:

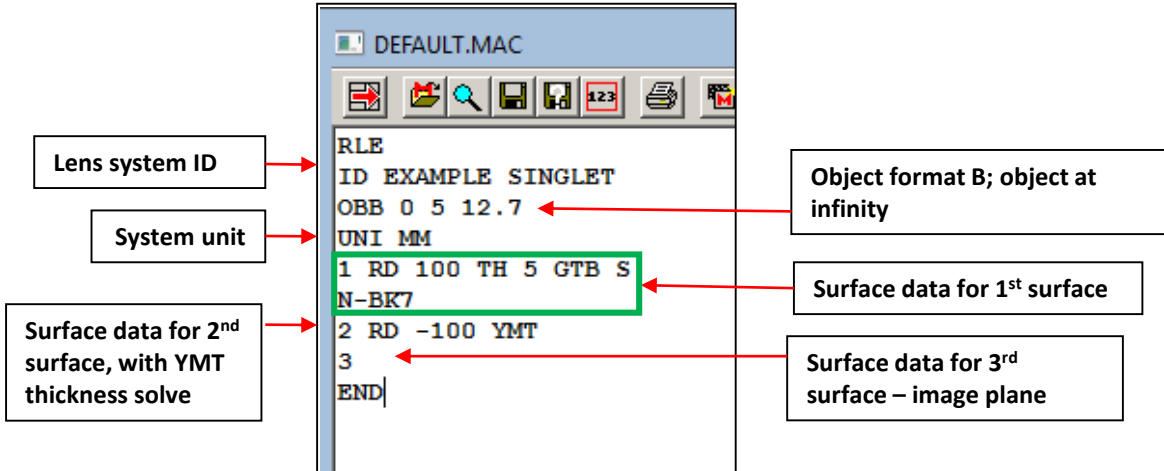

### 1. OBB (B-type object) syntax (User Manual 3.1.1 Object Input Description):

OBB UMPO UPPO YMP1 [ YP1 UXP0 XP1 XMP1 ]

<b><u>YMP1</u></b>	axial marginal ray height on surface 1 vertex plane.
<b><u>YP1</u></b>	principal ray height on surface 1 vertex plane.
<b><u>XP1</u></b>	principal ray height on surface 1 X-axis, from the object at XP0 or UXP0
<b><u>XMP1</u></b>	X-dimension of axial marginal ray
<b><u>UMPO</u></b>	paraxial marginal ray angle in degrees. Used chiefly for infinite conjugate, for which UMPO = 0.
<b><u>UPPO</u></b>	field angle in degrees of object on Y-axis, measured at the vertex of surface 1. The value must be non-zero.
<b><u>UXP0</u></b>	paraxial chief ray angle in degrees for object on X-axis, measured at the vertex of surface 1

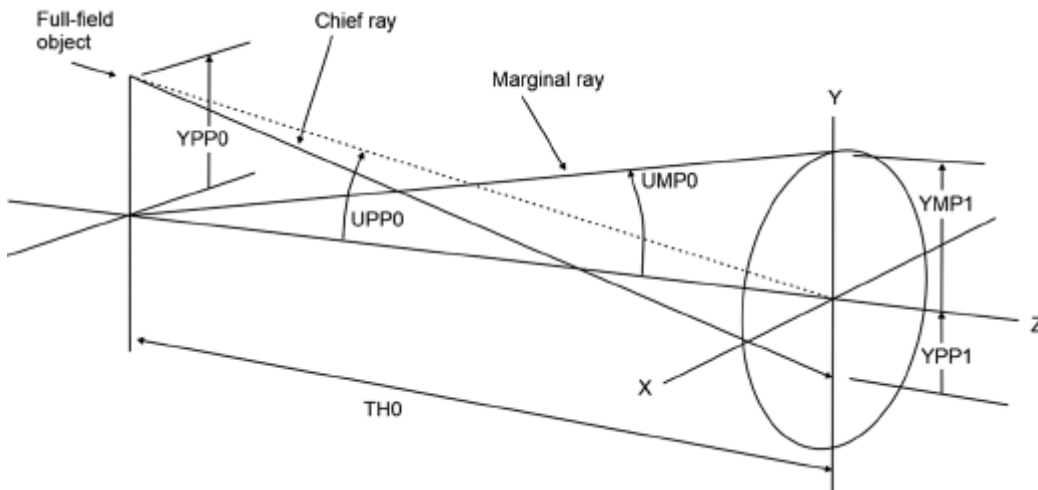

Note: SYNOPSIS™ uses Left Hand Coordinate as default. For more on this, see **User Manual 2.4 Coordinate systems**.

## 2. Surface Data Input

The general syntax for surface data input is:

SN opt1 opt2 opt3...

where SN is the surface number, and some of the available options are listed below:

<b>Curvature options:</b>	
Format: <u>SN</u> <u>option</u>	
Where <u>option</u> is one of the following:	
NULL	
SPH	
RD <u>NB</u>	NDEF
RAD <u>NB</u>	DC1 <u>G1</u> <u>G3</u> <u>G6</u> <u>G10</u> <u>G16</u>
CV <u>NB</u>	DC2 <u>G2</u> <u>G4</u> <u>G5</u> <u>G7</u> <u>G8</u> <u>G9</u>
NCOP	DC3 <u>G11</u> <u>G12</u> <u>G13</u> <u>G14</u> <u>G15</u> <u>G17</u>
PCV <u>NB</u> [ <u>M</u> [ <u>B</u> ] ]	AT1 <u>G1</u> <u>G2</u> <u>G3</u> <u>G4</u>
UMC <u>NB</u>	AT2 <u>G5</u> <u>G6</u> <u>G7</u> <u>G8</u>
UPC <u>NB</u>	AT3 <u>G9</u> <u>G10</u> <u>G11</u> <u>G12</u>
YMC <u>NB</u>	AT4 <u>G13</u> <u>G14</u> <u>G15</u> <u>G16</u> <u>G17</u>
YPC <u>NB</u>	GRATING { <u>X</u> } <u>L/MM</u> <u>ORDER</u>
VMC <u>NB</u>	CC <u>NB</u> { <u>Y</u> }
VPC <u>NB</u>	B <u>NB</u>
XMC <u>NB</u>	A <u>NB</u>
XPC <u>NB</u>	TORIC <u>RX</u>
AMY	ASTORIC <u>RX</u>
APY	BICONIC <u>KX</u> <u>KY</u>
CCY	NCZONE <u>COSPHI</u>
IMY <u>NB</u>	BRD <u>B</u> <u>A</u> <u>C</u>
IPY <u>NB</u>	FRESNEL
AMX	USSHAPE <u>TYPE</u>
APX	
CCX	
IMX <u>NB</u>	
IPX <u>NB</u>	

<b>Thickness options:</b>
<u>SN</u> <u>TH</u> <u>NB</u>
<u>SN</u> <u>PTH</u> <u>NB</u> [ <u>M</u> <u>B</u> ]
<u>SN</u> <u>YMT</u> <u>NB</u>
<u>SN</u> <u>YPT</u> <u>NB</u>
<u>SN</u> <u>XMT</u> <u>NB</u>
<u>SN</u> <u>XPT</u> <u>NB</u>
<u>SN</u> <u>NTOP</u>

Glass and index options:

<u>SN</u> <u>GTB</u> { <u>S</u> <u>O</u> <u>H</u> <u>C</u> <u>F</u> <u>U</u> <u>G</u> <u>R</u> } / <u>type</u>
<u>SN</u> { <u>AIR</u> / <u>VACUUM</u> }
<u>SN</u> <u>NIOP</u>
<u>SN</u> <u>PIN</u> <u>NB</u>

<b>Examples of index input:</b>
2 AIR
5 N13 836505 846663 872041
12 GTB S
K5
14 GTB S "SF16"
33 GLM 1.517 64.5

### 3. YMT Paraxial solves

paraxial solves, an important concept that will be used frequently. When a solve is defined, the program will calculate the actual curvature or thickness so as to satisfy a paraxial requirement, and you do not then give it a value yourself.

When we select the YMT solve, SYNOPSIS™ finds the thickness (T) such that the height (Y) of the marginal paraxial ray (M) will be the requested value (zero) at the next surface. In other words, surface 3 will be at the paraxial focus. This is an example of **paraxial solve**.

There are many kinds of solves (see the Table below). Whenever you want to learn about one, or read about any other term used in this guide, we can use the Help file. For example: Type HELP YMT in the Command Line will open the Help page for YMT:

#### SYNOPSIS AI>HELP YMT

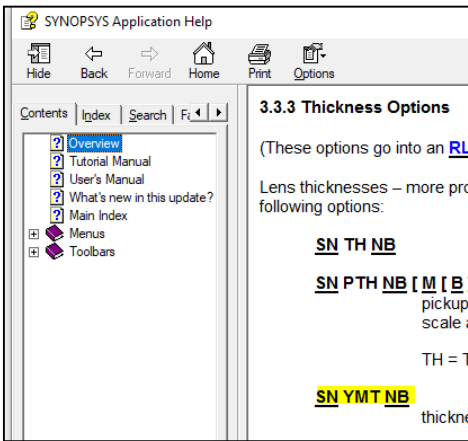

#### List of Paraxial Solves in SYNOPSIS™

<b>UMC NB</b>	<b>Curvature solves:</b> U is a paraxial angle Y is a paraxial height M is the marginal ray P is the principal ray (the chief ray) C designates a curvature solve T is a thickness solve Thickness solves
<b>UPC NB</b>	
<b>YMC NB</b>	
<b>YPC NB</b>	
<b>APC</b>	
<b>CCC</b>	
<b>YMT NB</b>	
<b>YPT NB</b>	

# APPENDIX

## Optimization Introduction

In this appendix, we will give a brief introduction to the optimization method in SYNOPSIS™. We will discuss:

1. The optimization PArAmeter iNpuT (PANT) file/module
2. The optimization AberrAtion iNpuT (AANT) file/module
3. Ready-made merit function

Here's the structure of an optimization macro:

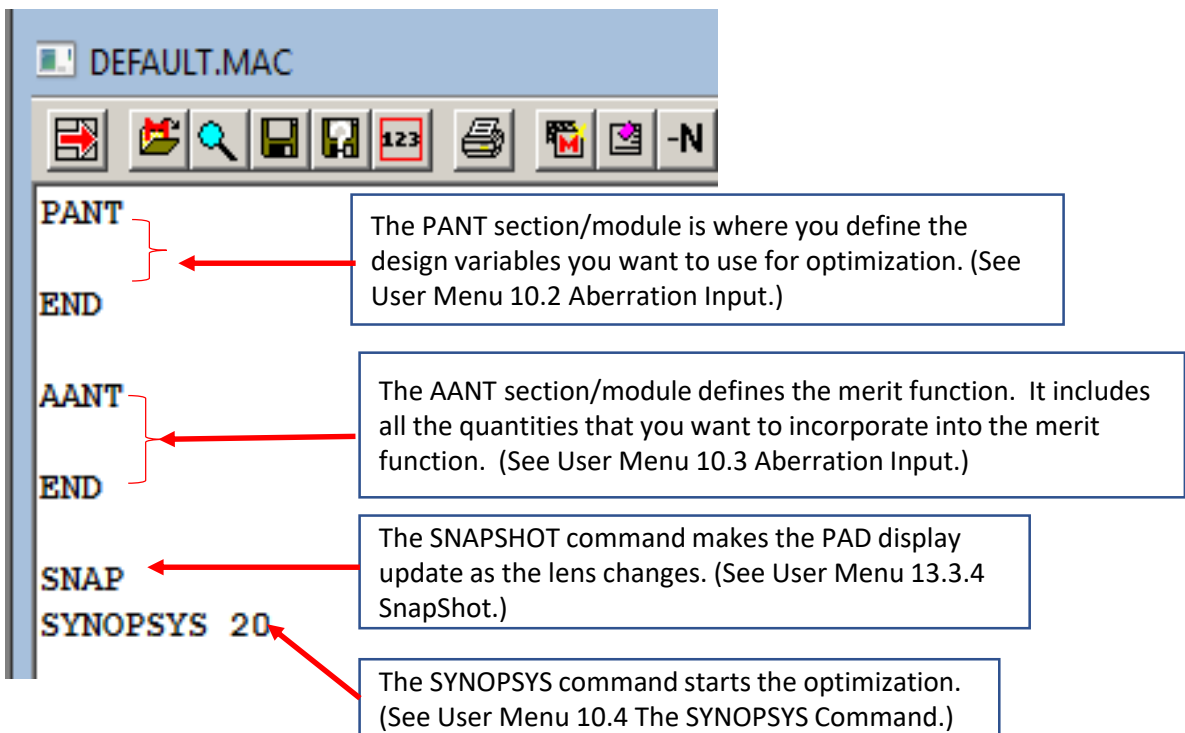

1. The PANT (Parameter iNpuT) file includes all the design variables for optimization. Below is a list of available parameter inputs. All the inputs need to be enclosed between the keywords PANT and END. You can choose from the list to define your optimization parameters. For more details, see **User Manual 10.2 Parameter Input**.

```

PANT [P]
[ RDR FRACTION ]
[ CBOUNDS ND1 VD1 ND2 VD1 ]
[ FBOUNDS ND1 VD1 ND2 VD1 ]
[ CLIMIT UPPER LOWER ]
[ TLIMIT UPPER LOWER ]
[ SLIMIT UPPER LOWER ]
[ CUL CROWNLIMIT ]
[ FUL FLINTLIMIT ]
[ CLL CROWNLLIMIT ]
[ FLL FLINTLLIMIT ]
VY SN parameter [ UPPER LIMIT LOWER LIMIT [ INCREMENT ] ]
VLIST parameter SN SN SN ...
VLIST RAD ALL [ EXCEPT SN SN SN ...]
VLIST CSUM ALL [ EXCEPT SN SN SN ...]
VLIST CDIFF ALL [ EXCEPT SN SN SN ...]
VLIST TH ALL
VLIST TH ALL EXCEPT SN SN SN ...
VLIST TH ALL OVER VALUE
VLIST TH ALL OVER VALUE EXCEPT SN SN SN ...
VLIST TH ALL GLASS
VLIST TH ALL GLASS EXCEPT SN SN SN ...
VLIST TH ALL GLASS OVER VALUE
VLIST TH ALL GLASS OVER VALUE EXCEPT SN SN SN ...
VLIST TH ALL AIR
VLIST TH ALL AIR EXCEPT SN SN SN ...
VLIST TH ALL AIR OVER VALUE
VLIST TH ALL AIR OVER VALUE EXCEPT SN SN SN ...
VLIST GLM ALL [ EXCEPT SN SN SN ...]
VLIST CC ALL [ EXCEPT SN SN SN ...]
VLIST G ALL [ EXCEPT SN SN SN ...]
VY SN NURBS
VY SN XNURBS
VY SN ZERNIKE [ SYMM / RSYMM / NLSYMM ]
VY SN DOE [ SHAPE ] [ UPPER LIMIT LOWER LIMIT INCREMENT ]
VY SN DCA [ SYMM / RSYMM ]
END

```

- The keyword VLIST means ‘Vary a LIST’ of parameters. For example, VLIST RAD ALL means to vary the radius of curvature for all the surfaces in the system.
- The keyword VY means VarY one parameter on one surface. For example, VY 1 RD means to vary the radius of curvature for surface 1.
- The VLIST options utilizes default limits and increments for variables so entered.
- To modify the default limits and bounds, you can use the commands enclosed in the green square to do so. The upper and lower limits give the range through which the parameter is allowed to move. The RDR fraction command is used to control the increment for calculating the derivative with the finite difference method.
- In the default mode of SYNOPSIS™, the optional [ P ] on the PANT line has no effect. This mode gives the minimum amount of printout during optimization, and automatically includes a listing of the input data for PANT and AANT (see 10.3). If [mode switch 29](#) is turned off (see 10.5), the program will examine the PANT command for the [ P ] and will echo the input if this is present. If the P is not present it will print a more lengthy, but readable, record of all variables for the run. In other words, if you want a very short listing, turn on switch 29. For an input echo, turn off 29 and include the P, and for a longer summary leave the P off as well.

- One can exclude surfaces from the ALL variables by declaring them following the EXCEPT mnemonic, which is in word 4 of the line.

```

VLIST parameter SN SN SN ...
VLIST RAD ALL [ EXCEPT SN SN SN ...]
VLIST CSUM ALL [ EXCEPT SN SN SN ...]
VLIST CDIFF ALL [ EXCEPT SN SN SN ...]

VLIST TH ALL
VLIST TH ALL EXCEPT SN SN SN ...
VLIST TH ALL OVER VALUE
VLIST TH ALL OVER VALUE EXCEPT SN SN SN ...

VLIST TH ALL GLASS
VLIST TH ALL GLASS EXCEPT SN SN SN ...
VLIST TH ALL GLASS OVER VALUE
VLIST TH ALL GLASS OVER VALUE EXCEPT SN SN SN ...

VLIST TH ALL AIR
VLIST TH ALL AIR EXCEPT SN SN SN ...
VLIST TH ALL AIR OVER VALUE
VLIST TH ALL AIR OVER VALUE EXCEPT SN SN SN ...

VLIST GLM ALL [ EXCEPT SN SN SN ...]

VLIST CC ALL [ EXCEPT SN SN SN ...]

VLIST G ALL [ EXCEPT SN SN SN ...]

```

- VLIST parameter

```

VLIST parameter SN SN SN ...

```

Where parameter is a code word identifying the parameter, taken from the list below.

<u>RD, RAD or CV</u>	<u>VZN</u>	<u>AG</u>	<u>AL</u>
<u>TH</u>		<u>BG</u>	<u>BL</u>
<u>INDEX</u>	<u>AP1 NB</u>	<u>GG</u>	<u>GL</u>
<u>VD</u>	<u>AP2 NB</u>	<u>XG</u>	<u>XL</u>
<u>GLASS or GLM</u>	<u>TH0</u>	<u>YG</u>	<u>YL</u>
<u>GBF</u>	<u>YP0</u>	<u>ZG</u>	<u>ZL</u>
<u>GBC</u>	<u>YMP1</u>	<u>AT NB</u>	<u>XDC NB</u>
<u>ASPH</u>	<u>YP1</u>	<u>BT NB</u>	<u>YDC NB</u>
<u>CC</u>	<u>LHG NB</u>	<u>GT NB</u>	<u>ZDC NB</u>
<u>ACCOMMODATE</u>	<u>RHG NB</u>	<u>BTH</u>	<u>GC NB</u>
<u>ZDATA NZOOM</u>	<u>CAO</u>	<u>G NB</u>	<u>GOUT</u>
<u>XP1</u>	<u>XMP1</u>	<u>XE</u>	<u>YE</u>
<u>ZE</u>	<u>AE</u>	<u>BE</u>	<u>GE</u>
<u>GPA</u>	<u>GPB</u>	<u>GPG</u>	<u>ZTH0</u>
<u>PTH0</u>	<u>UP0</u>	<u>UB0</u>	
<u>CSUM</u>	<u>CDIFF</u>	<u>CAX</u>	<u>CAY</u>
<u>PGM</u>			



2. The AANT (Aberration iNpuT) file includes all the aberration terms to be considered in the merit function for optimization. For a more complete discussion, please refer to the **User Manual 10.3 Aberration Input** and **Tutorial Manual ch. 6 Optimization with SYNOPSIS™** .

The aberration terms can be classified into three categories in accordance to their distinct syntax:

- A. Automatic generation of ray aberrations (ray grid aberrations)
- B. User-specified aberrations
- C. Optimization monitors

This is an exemplary AANT file:

AANT		Category
AEC	Automatic Edge Control	C. Optimization monitor
GSR .5 2 5 2 0	Corrects 5 rays in color 2, on axis	A. Auto ray grid aberration
GNR .5 1 4 1 1	Ray grid, color 1, full field	A. Auto ray grid aberration
GNR .5 1 4 2 1	same, color 2	A. Auto ray grid aberration
GNR .5 1 4 3 1	and color 3	A. Auto ray grid aberration
M 0 10 A 1 YA 1 S 3 YA 1	Corrects chromatic aberration. The rays in colors 1 and 3 at full field should have the same Y-intercept (YA), with a weight of 10.	B. User-specified aberration
END		

**Note:**

We can also classify all the aberrations in accordance to their physical properties. For example:

- Ray-based aberrations, including transverse coordinates and OPD's
- Paraxial aberrations
- Construction parameter aberrations
- Diffraction MTF aberrations

You can also construct **composite aberrations** by combining different aberration terms. (See **User Manual 10.3**)

## Automatic Ray Grid Aberration:

The automatic ray-generating feature constructs a ray pattern of a selected type and adds selected properties of the rays to the merit function. The target and weight of each ray or blur size is assigned by the program according to the rules implied in the pattern mnemonic. Input consists of one or more of the following lines:

<b>GNR</b> <u>RT</u> <u>WT</u> <u>DEL</u> <u>ICOL</u> <u>HBAR</u> <u>GBAR</u> [ <u>SN</u> [ <u>F</u> [ <u>XWT</u> ] ] ]	transverse coordinates
<b>GXR</b> <u>RT</u> <u>WT</u> <u>DEL</u> <u>ICOL</u> <u>HBAR</u> <u>GBAR</u> [ <u>SN</u> [ <u>F</u> ] ]	only correct XC coordinates
<b>GYR</b> <u>RT</u> <u>WT</u> <u>DEL</u> <u>ICOL</u> <u>HBAR</u> <u>GBAR</u> [ <u>SN</u> [ <u>F</u> ] ]	only correct YC coordinates
<b>GSR</b> <u>RT</u> <u>WT</u> <u>DEL</u> <u>ICOL</u> <u>HBAR</u> <u>GBAR</u> [ <u>SN</u> [ <u>F</u> ] ]	sagittal fan only, correct <u>XC</u>
<b>GTR</b> <u>RT</u> <u>WT</u> <u>DEL</u> <u>ICOL</u> <u>HBAR</u> <u>GBAR</u> [ <u>SN</u> [ <u>F</u> ] ]	tangential fan only, correct <u>YC</u>
<b>GPR</b> <u>RT</u> <u>WT</u> <u>DEL</u> <u>ICOL</u> <u>HBAR</u> <u>GBAR</u> [ <u>SN</u> [ <u>F</u> [ <u>XWT</u> ] ] ]	errors from <u>principal</u> ray
<b>GNO</b> <u>RT</u> <u>WT</u> <u>DEL</u> <u>ICOL</u> <u>HBAR</u> <u>GBAR</u> [ <u>0</u> <u>F</u> ]	OPD targets
<b>GSO</b> <u>RT</u> <u>WT</u> <u>DEL</u> <u>ICOL</u> <u>HBAR</u> <u>GBAR</u> [ <u>0</u> <u>F</u> ]	sagittal fan only
<b>GTO</b> <u>RT</u> <u>WT</u> <u>DEL</u> <u>ICOL</u> <u>HBAR</u> <u>GBAR</u> [ <u>0</u> <u>F</u> ]	tangential fan only
<b>GPO</b> <u>RT</u> <u>WT</u> <u>DEL</u> <u>ICOL</u> <u>HBAR</u> <u>GBAR</u> [ <u>0</u> <u>F</u> ]	reference at principal ray
<b>GO2</b> <u>RT</u> <u>WT</u> <u>DEL</u> <u>ICOL</u> <u>HBAR</u> <u>GBAR</u> [ <u>0</u> <u>F</u> ]	OPD targets squared
<b>GNN</b> <u>0</u> <u>WT</u> <u>DEL</u> <u>ICOL</u> <u>HBAR</u> <u>GBAR</u> [ <u>SN</u> ]	correction to centroid
<b>GNV</b> <u>0</u> <u>WT</u> <u>DEL</u> <u>ICOL</u> <u>HBAR</u> <u>GBAR</u> [ <u>0</u> <u>F</u> ]	wavefront variance
<b>GPV</b> <u>0</u> <u>WT</u> <u>DEL</u> <u>ICOL</u> <u>HBAR</u> <u>GBAR</u> [ <u>0</u> <u>F</u> ]	reference at principal ray
<b>GTP</b> <u>RT</u> <u>WT</u> <u>DEL</u> <u>ICOL</u> <u>0</u> <u>0</u> <u>SN</u>	pupil aberrations on surface SN
<b>GDR</b> <u>0</u> <u>WT</u> <u>DEL</u> [ <u>ICOL</u> / <u>P</u> ] <u>HX</u> <u>HY</u> [ <u>0</u> <u>F</u> ]	array to correct distortion. <u>HX</u> and <u>HY</u> give the target XA and YA for the chief ray at full field in X and Y. If XPP0 is zero, only targets in Y are considered. If "F" is in word 9, both positive and negative GBARs are corrected. (This form does not support color "M".)
<b>GSHEAR</b> <u>SHEAR</u> <u>WT</u> <u>DEL</u> <u>ICOL</u> <u>HBAR</u> <u>GBAR</u> [ <u>X</u> / <u>Y</u> [ <u>F</u> ] ]	See below.

Gxy:

x = N -> 2D raygrid  
x = S/T -> Sagittal/Tangential ray fan  
x = P -> reference to principal ray

Gxy:

y = R -> ray fan aberration (transverse)  
y = O -> OPD  
y = V -> wavefront variance

- For **GNR** requests, each ray is traced only once even though two aberrations are generated (XC and YC).
- If **GNO** is entered, a single aberration, namely the OPD of the ray, is generated for each ray.
- **GSR** and **GTR** generate rays in the sagittal or tangential fan only.
- **GPR** and **GPO** define the ray error with reference to the *principal* ray location, rather than the chief ray. (The chief ray is always taken in the primary color, while the *principal ray* is in the color of the rayset.) This is useful for designing spectrometers, where the images in several colors are widely separated.
- The chief ray is always taken in the primary color, while the *principal ray* is in the color of the rayset. This is useful for designing spectrometers, where the images in several colors are widely separated.
- **XC/YC** is the X/Y coordinate of the ray with respect to that of the chief ray in the primary color (see next slide for discussion on primary color).

**GNN** corrects the rays relative to the centroid of that set of rays rather than to the chief ray intercept, and always traces over the full pupil (since the centroid of a pencil over only half the pupil is itself decentered and would be inappropriate). While **GNR** generates two aberrations for each ray, **GNN** generates only one aberration for the whole set: the mean squared spot size measured from the centroid. For best results, a lens should be optimized as far as possible with individual ray aberrations or **GNR** requests, and the **GNN** option used only to peak up the final image. The **GNN** option also permits the centroid coordinates to be controlled explicitly. (See [section 10.3.3.](#)) Since the GNN option ignores the location of the chief ray, it will not automatically control lateral color, and specific targets should be added for that purpose.

**GNV** causes the variance in the wavefront to be computed for all of the generated rays. It is useful in the final stages of a design to peak up the performance. Note that neither **GNN** nor **GNV** honors a nonzero **RT** entry; all rays are weighted equally. The variance is taken relative to a sphere centered at the primary-color chief ray point. The effects of lateral color are therefore corrected automatically if the requested color is not the primary color. For peaking the MTF at a given frequency, the GSHEAR option is superior.

The **GPV** option is similar to GNV, except that the OPD reference sphere is centered at the image point in the requested color. This is the point that minimizes the variance in that color, and it is usually not exactly at the chief-ray point. GPV is useful when you want each color to form a sharp image, but don't care about lateral color, which is not controlled by this option.

**GO2** is similar to GNV but is usually more powerful. Although minimizing the variance (with GNV) in principle should maximize the Strehl ratio, it suffers from two defects. First, the variance is not sensitive to the *average* OPD, since it is defined as the average of the squares minus the square of the average. So if both of these are large the program only controls the difference, and the OPDs themselves are not strongly driven toward a value of zero. Also, the process discards the sign information of each OPD. In contrast, GO2 calculates the *square of each OPD* and then assigns the sign of the OPD itself to the result. The net effect is to reduce the sum of the squares of the OPDs, which reduces the variance as well if the average is zero, while at the same time trying to reduce each OPD to zero to make this the case.

**GSHEAR** is an alternative to MTF [aberrations](#), which work but can only be used when the design is very close to perfect already. GSHEAR also works best if it is already close to a good solution, but it is more forgiving and can be used earlier in the process. This form creates traces two rays for each point in the pattern, sheared in X or Y in the pupil with respect to that point. The purpose is to improve the convolution MTF at the entered shear value. It also accepts colors "M" and "P". The shear value is a fraction of the semi-aperture. Thus, a shear of 1.0 corresponds to the cutoff frequency, and values of 0.5 or less are usually appropriate. The RT value does not apply to this form. Larger shear values produce fewer rays, since rays sheared out of the pupil are ignored.

**GTP** generates a TFAN of rays all passing through the center of the entrance pupil. The fan in this case is a collection of HBAR points. This feature is used to correct the spherical aberration of the pupil on a given surface. Be warned that if your lens uses any of the wide-angle (WAP) pupil options or the VFIELD, then the chief rays will in general *not* go through the center of the stop, and using the GTP feature may not make sense.

Brief explanation to the GSR and GNR commands (**10.3.1.1 Automatic generation of ray aberrations**):

- GNR and GSR are the built-in ray grid aberration terms that can be included in the AANT file to construct the merit function.
- **GNR** request will generate a YC and an XC aberration for each ray in a grid, the resolution of which is given by the entry **DEL**. This entry represents the number of partitions to be made to the semi-aperture, as shown below. **GSR** (or **GTR**) generate rays in the sagittal (or tangential) fan only for the correction of XC (or YC). XC (or YC) is the X-coordinate (or Y-coordinate) of the ray with respect to that of the chief ray in the primary color.
- Syntax:
  - GNR RT WT DEL ICOL HBAR GBAR**
  - GSR RT WT DEL ICOL HBAR GBAR**
  - **RT** is an aperture-dependent weighting factor which assign different weights to different zone of the pupil according to a preset formula (see **10.3.1.1 Automatic generation of ray aberrations** for more details)
  - **WT** defines the weight of the aberration term to the merit function
  - **DEL** defines the resolution of the raygrid (ie, number of rays); see below
  - **ICOL** is the color number: **M** for multiple color, **P** for the primary color, number 1 stands for the 1<sup>st</sup> wavelength declare in the system, etc...
  - **HBAR** is the fractional object height in the Y direction
  - **GBAR** is the fractional object height in the X direction
- When you use the letter "**M**" for the **ICOL**, it causes a set of ray aberrations to be generated at all defined colors. If you want different weights on each color, you have to enter separate requests for each one. The multi-color declaration at the left is equivalent to the declaration at the right for a system with 3 wavelengths of equal spectrum weighting:

```
GSR .5 10 5 M 0
GNR .5 2 3 M .7
GNR .5 1 3 M 1
```

```
GSR .5 10 5 P 0
GSR .5 10 5 1 0
GSR .5 10 5 3 0
GNR .5 2 3 P .7
GNR .5 2 3 1 .7
GNR .5 2 3 3 .7
GNR .5 1 3 P 1
GNR .5 1 3 1 1
GNR .5 1 3 3 1
```

- Illustration of ray grid resolution control (DEL):

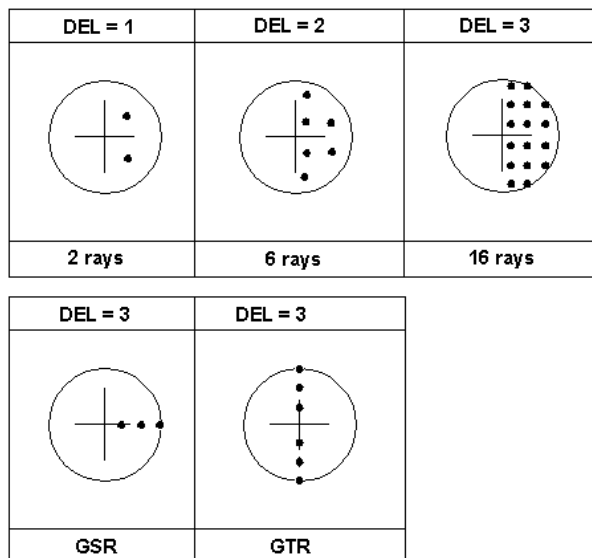

## B. User-specified aberrations

As shown below, the user-specified aberration always consist of two components: GOALS and DETAILS

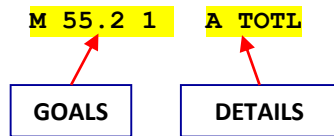

Here, the GOALS section says to Minimize to a target value of 55.2 with a relative weight of 1 the quantity in the DETAILS section, in this case the TOTL length of the lens. The “A” in that section means Add this quantity. You may have several items in the DETAILS section, combined with A (Add), S (Subtract), MUL (MULTiply), and DIV (DIVide). For example, to control the sum of thicknesses 4 and 5, you could enter the following commands:

```
M 34.567 A TH 4
A TH 5.
```

Note that the second item in the details (A TH 5) starts in a new line in the following example. But you can also use a '/' to separate the two details and rewrite the last user-specified aberration as

```
M 34.567 A TH 4/A TH 5.
```

The most frequently used format is:

```
M tar wt A aberration
```

Minimize the *aberration* item Added to the designated *tar* with a weight of *wt*

Another frequently used format is:

```
LLL tar wt wind A aberration
```

This is a one-sided aberration that sets a lower limit (*tar*) with a weight of *wt* for the quantity (*aberration*) in the DETAILS. Similarly

```
LUL tar wt wind A aberration
```

sets an upper limit (*tar*) with a weight of *wt* for the quantity (*aberration*) in the DETAILS. For example, **LUL 250 1 1 A TOTL** limits the total length to be no larger than 250.

To explain the *wind* (window) parameter, consider the **LUL** form first. If the quantity to be controlled is less than *tar* (target), the aberration is zero because this is an upper limit and we don't care in that case. For values that exceed *tar* (target), the aberration varies as the square of the departure from *tar* (target), calculated so that if the excess is just equal to *wind* (window), the aberration value is equal to *wt* (weight). So the *tar*, *wt*, *wind* are all connected. You can use this as a guideline to choose the proper value for *wind*. Nonetheless, you can also use the approach of trial and error to experiment with the *wind* parameter.

The following table summarizes all the allowable variations for the GOALS. See **User Manual 10.3.5.1 Limit Input** for the use of the other variations.

GOALS	DETAILS
$\left\{ \begin{array}{l} M \\ L \\ LIM \\ MF \end{array} \right\} \text{ TAR WT } \left[ \begin{array}{l} SCR \\ SR \end{array} \right]$ $LL \ A1 \ F1 \ A2 \ F2$ $C \ \text{TAR WT}$ $[ \text{LUL} / \text{LLL} ] \ \text{TAR WT WIND}$	$\left\{ \begin{array}{l} A \\ S \\ MUL \\ DIV \end{array} \right\} \text{ aberration}$

You can also use the NAME aname command to add a label to the user-specified aberration. The aname is an optional string of up to 8 characters, consisting of all numbers or starting with a letter with no punctuation marks or spaces within the name. This name will appear on the ALIST and FINAL output to help you identify individual aberrations.

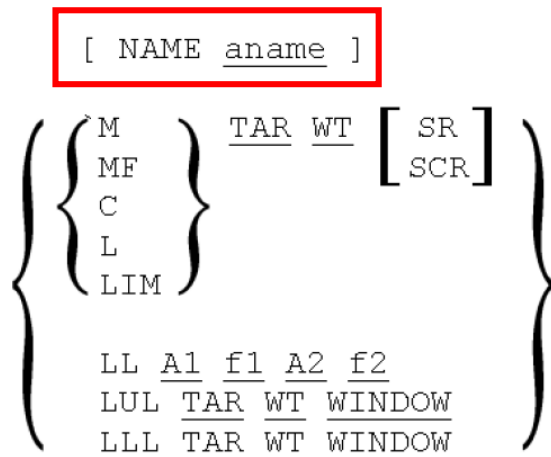

For the DETAILS section in the user-defined aberration, there are a lot of aberration terms to choose from. See **User Manual 10.3** for more details. Here we only list the format for defining user-specified ray aberrations (**User Manual 10.3.1.2**):

**{ A / S / MUL / DIV } { ICOL / P } name HBAR XEN YEN GBAR [ SN ]**

- **A**, **S**, **MUL**, and **DIV** determine how this component of the aberration is to be combined with any previous components to form the combination (added to, subtracted from, multiplied by, or divided into)
- **ICOL** is the color number. You may substitute “P” for the primary color, but you may *not* use “M”.
- **HBAR** is the fractional object height in the Y direction.
- **XEN** is the fractional entrance pupil coordinate in the X direction.
- **YEN** is the fractional entrance pupil coordinate in the Y direction.
- **GBAR** is the fractional object height in the X direction
- **SN** is the surface number on which the ray intercept is to be computed. The default surface is the image plane. This should not be entered for OPD requests, which are only valid at the image
- **name** is one of the following:

	<a href="#">YA</a>	<a href="#">ZA</a>	<a href="#">RA</a>	<a href="#">XG</a>	<a href="#">XL</a>
	<a href="#">YC</a>	<a href="#">OPD</a>	<a href="#">RC</a>	<a href="#">YG</a>	<a href="#">YL</a>
	<a href="#">YP</a>	<a href="#">OPP</a>	<a href="#">HFREQ</a>	<a href="#">ZG</a>	<a href="#">ZL</a>
	<a href="#">XA</a>	<a href="#">ZZ</a>	<a href="#">HBRAGG</a>	<a href="#">ZZG</a>	<a href="#">ZZL</a>
	<a href="#">XC</a>	<a href="#">HH</a>	<a href="#">HEFFIC</a>	<a href="#">HHG</a>	<a href="#">HHL</a>
	<a href="#">XP</a>	<a href="#">DSLOPE</a>	<a href="#">HSFREQ</a>	<a href="#">FLUX</a>	<a href="#">PL</a>
	<a href="#">XE</a>	<a href="#">YE</a>	<a href="#">ZE</a>	<a href="#">ZZE</a>	<a href="#">HHE</a>
	<a href="#">ERROR</a>	<a href="#">UNI</a>	<a href="#">UNR</a>	<a href="#">OPL</a>	<a href="#">ILLUM</a>

**Example user-defined rays:**

```
M 0 1 A 2 YA 0 0 1           M 22 1
                              A P OPL 0 0 1 0 5 13

M 0 10 A 1 YA 1 0 0
S 3 YA 1 0 0
```

### C. Optimization monitors (User Manual 10.3 Aberration Input ):

The optimization monitors are a set of control that keep certain aspects of the lens from becoming unreasonable. You can use the 'Monitors' button in the Macro Editor toolbar to view and select the monitors available in SYNOPSIS™:

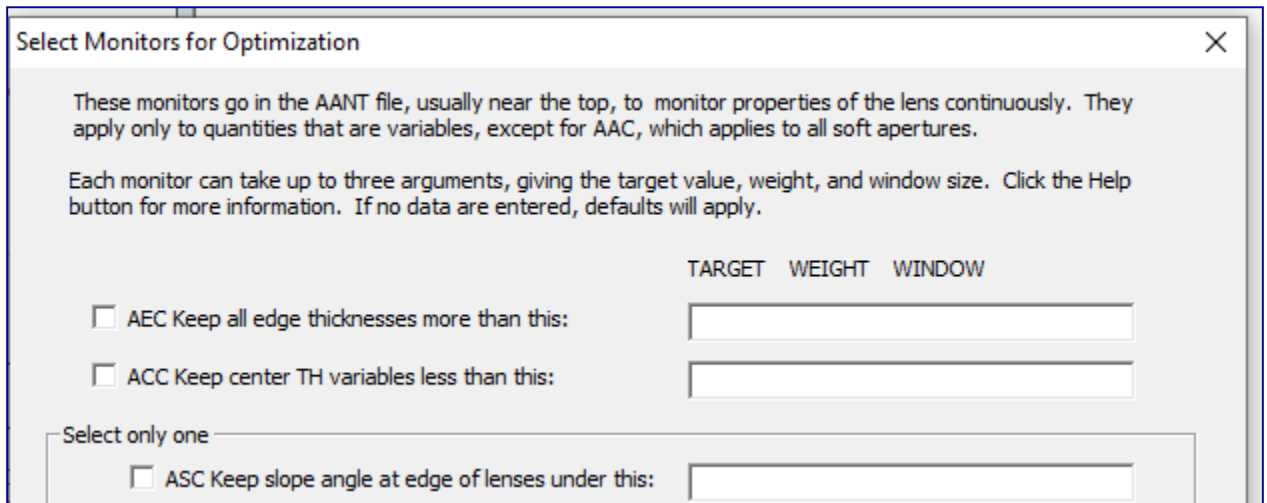

[AEC](#) to monitor edge thicknesses, where TH is varying.

[AGE](#) to monitor edge thickness of glass elements, where TH is varying.

[AFE](#) monitors edges, as does AGE, but at the apertures given by [EFILE](#) points A and E if defined, or at the CAO if not.

[AAE](#) to monitor edge thicknesses of airspaces, where TH is varying.

[ACC](#) to control maximum center thicknesses of elements, where TH is varying.

[ACM](#) to control minimum center thicknesses, where TH is varying.

[ASC](#) to prevent surface slopes from becoming too steep at the rim rays, where CV is varying.

[ACS](#) to prevent surface slopes from becoming too steep at the CAO, where CV is varying.

[ACA](#) to prevent rays from entering or leaving an element too close to the critical angle, where the CV is varying.

[ATC](#) checks the angle from normal of all rays traced by ray errors in the merit function. This is to prevent critical angle errors if the angle gets too steep.

[AAC](#) aperture control, to monitor clear apertures and keep them from getting too large. This applies to all apertures.

[AZA](#) to monitor the airspace on both sides, and the edge dimensions, of each zoom group in a ZFILE zoom lens.

[ADT](#) to monitor the ratio of lens diameter to thickness.

[ADS](#) to monitor the ratio of lens diameter to thickness, adding surface sag to the thickness. This accounts for the greater stiffness of meniscus elements..

[AMS](#) to monitor the separation between centers of curvature of meniscus lenses.

[ARC](#) to monitor the position of the chief ray within the beam throughout the lens.

Each of these has optional parameters to control how they are applied.

## D. Ready-made merit function

There are 9 ready-made merit functions that can be accessed using the 'Ready-made merit function (or Rayset)' button in the Macro Editor toolbar.

Most lenses work well with selection 6. This specifies an SFAN of five rays on axis, in three colors, and a grid of three rays in both X and Y at field points 0.0, 0.7, and 1.0, also in three colors. This option traces more rays than do selections 1 through 5, but will correct for chromatic differences in the aberrations, which the former will not.

Selections 1 and 2 are for monochromatic systems, while selections 3, 4, and 5 correct three colors by targeting the difference in ray intercept points in the long and short wavelengths, and a grid or fan of rays in the primary color.

Selection 5 has a finer grid than selection 4 and is useful when the lens shows high-order aberrations.

Selections 1 and 3 correct the image at just the on-axis point.

Selection 7 is intended for systems without axial symmetry. It traces over both halves of the pupil, and corrects the on-axis point as well as the full-field points in both HBAR and GBAR. You will probably want to add several more field points to the merit function if you select this option, but this depends on the characteristics of your lens.

Number 8 is intended for systems near the diffraction limit. It is often a good idea in that case to include a combination of both transverse aberrations and OPD targets in the merit function. But the relative weights must be carefully adjusted: an OPD error of one wave is usually much better than an image blur of one inch. So the program finds a useful weighting for the OPD errors, based on the current F/number of the lens and the wavelength. You are of course encouraged to adjust the resulting weights as you see how things progress during optimization.

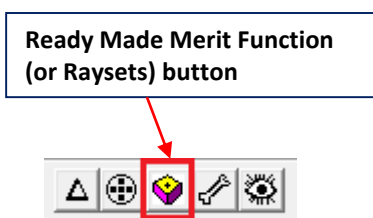



# SYNOPTSYS™

*(SYNthesis of OPTical SYStems)*  
Lens Design Software

[www.osdoptics.com](http://www.osdoptics.com)

[info@osdoptics.com](mailto:info@osdoptics.com)

SYNOPTSYS™ is a trade name used by Optical Systems Design commercially since 1981.

